



**1973-79 Ford F-Series/
1978-79 Bronco**
without Factory Air
**Gen 5 Evaporator Kit
(751685)**



18865 Goll St. San Antonio, TX 78266
Phone: 800-862-6658
Sales: sales@vintageair.com
Tech Support: tech@vintageair.com
www.vintageair.com



www.vintageair.com

Table of Contents

Cover..... 1

Table of Contents..... 2

Packing List/Parts Disclaimer..... 3

Information Page..... 4

Wiring Notice..... 5

Engine Compartment Disassembly, Passenger Compartment Disassembly..... 6

Passenger Compartment (Cont.)..... 7

Condenser Assembly and Installation, Compressor and Brackets, Passenger Side Wheel Well Modification..... 8

Engine Compartment, Passenger Side Inner Fender Modification, Firewall Modification..... 9

Dash Modification..... 10

Defrost Duct Installation, Center and Passenger-Side Louver Installation..... 11

Center and Passenger-Side Louver Installation (Cont.), Lubricating O-rings, Properly Seated O-ring Land..... 12

Evaporator Preparation, Firewall Insulation..... 13-14

A/C and Heater Hose Routing & Kick Panel Cover Installation..... 15-17

Evaporator Installation..... 18-20

A/C Hose Installation..... 21

Heater Hose and Heater Control Valve Installation..... 22

Drain Hose Installation..... 23

Duct Hose Routing..... 24

Wiring Installation..... 25-27

Control Panel Installation..... 28

Final Steps: Installation Check..... 29

Glove Box Installation, Final Steps: Completing the Install..... 30

Quality Crimp Guideline..... 31

Gen 5 Wiring Diagram..... 32

Gen 5 Wiring Connection Instruction..... 33

Operation of Controls..... 34

Troubleshooting Guide..... 35

Troubleshooting Guide (Cont.), Advanced Diagnostics and Troubleshooting Guide..... 36

Packing List..... 37



A detailed tech video outlining the installation process for the Gen IV kit (some parts may differ from the Gen 5 kit) is available on Vintage Air's YouTube channel at <https://bit.ly/3dBfx5X>.

Viewing the tech video along with the written instructions will provide the installer the most detailed installation procedure.



www.vintageair.com

Packing List: Evaporator Kit (751685)

No.	Qty.	Part No.	Description
1.	1	765200	Gen 5 Magnum Max Module with 404 ECU
2.	1	791685	Accessory Kit

**** Before beginning installation, open all packages and check contents of shipment. Please report any shortages directly to Vintage Air within 15 days. After 15 days, Vintage Air will not be responsible for missing or damaged items.**

1



Gen 5 Magnum Max
Module with 404 ECU
765200

2

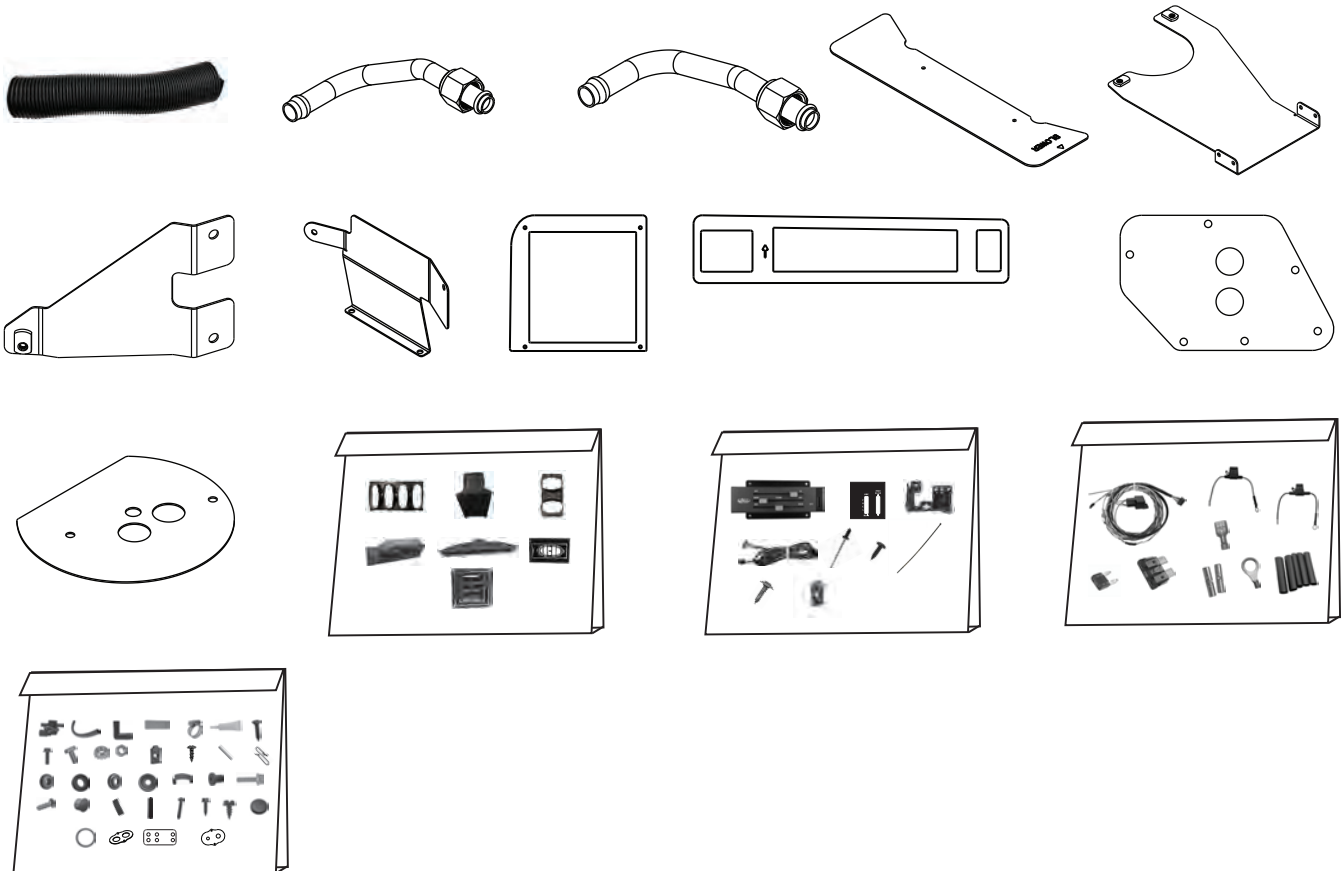

Accessory Kit
791685

NOTE: Images may not depict actual parts and quantities. Refer to packing list for actual parts and quantities.



www.vintageair.com

Important Notice—Please Read

For Maximum System Performance, Vintage Air Recommends the Following:

NOTE: Vintage Air systems are designed to operate with R134a refrigerant only. Use of any other refrigerant could damage your A/C system and/or vehicle, and possibly cause a fire, in addition to potentially voiding the warranties of the A/C system and its components.

Refrigerant Capacities:

Vintage Air System: 1.8 lbs. (28.8 oz.) or 816 grams of **R134a**, charged by weight with a quality charging station or scale. **NOTE: Use of the proper type and amount of refrigerant is critical to system operation and performance.**

Other Systems: Consult manufacturer's guidelines.

Lubricant Capacities:

New Vintage Air-Supplied Sanden Compressor: No additional oil needed (Compressor is shipped with proper oil charge).

All Other Compressors: Consult manufacturer (Some compressors are shipped dry and will need oil added).

Safety Switches

Your Vintage Air system is equipped with a binary pressure safety switch. A binary switch disengages the compressor clutch in cases of extreme low pressure conditions (refrigerant loss) or excessively high head pressure (406 PSI) to prevent compressor damage or hose rupture. A trinary switch combines Hi/Lo pressure protection with an electric fan operation signal at 254 PSI, and should be substituted for use with electric fans. Compressor safety switches are extremely important since an A/C system relies on refrigerant to circulate lubricant.

Service Info:

Protect Your Investment: Prior to assembly, it is critical that the compressor, evaporator, A/C hoses and fittings, hardlines, condenser and receiver/drier remain capped. Removing caps prior to assembly will allow moisture, insects and debris into the components, possibly leading to reduced performance and/or premature failure of your A/C system. This is especially important with the receiver/drier.

Additionally, when caps are removed for assembly, **BE CAREFUL!** Some components are shipped under pressure with dry nitrogen.

Evacuate the System for 35-45 Minutes: Ensure that system components (Drier, compressor, evaporator and condenser) are at a temperature of at least 85°F. On a cool day, the components can be heated with a heat gun **or** by running the engine with the heater on before evacuating. Leak check and charge to specifications.

Bolts Passing Through Cowl and/or Firewall:

To ensure a watertight seal between the passenger compartment and the vehicle exterior, for all bolts passing through the cowl and/or firewall, Vintage Air recommends coating the threads with silicone prior to installation.

Heater Hose (not included with this kit):

Heater hose may be purchased from Vintage Air (Part#31800-VUD) or your local parts retailer. Routing and required length will vary based on installer preference.



www.vintageair.com

Important Wiring Notice—Please Read

Some vehicles may have had some or all of their radio interference capacitors removed. There should be a capacitor found at each of the following locations:

- 1. On the positive terminal of the ignition coil.**
- 2. If there is a generator, on the armature terminal of the generator.**
- 3. If there is a generator, on the battery terminal of the voltage regulator.**

Most alternators have a capacitor installed internally to eliminate what is called “whining” as the engine is revved. If whining is heard in the radio, or just to be extra cautious, a radio interference capacitor can be added to the battery terminal of the alternator.

It is also important that the battery lead is in good shape and that the ground leads are not compromised. There should be a heavy ground from the battery to the engine block, and additional grounds to the body and chassis.

If these precautions are not observed, it is possible for voltage spikes to be present on the battery leads. These spikes come from ignition systems and charging systems, and from switching some of the vehicle’s other systems on and off. Modern computer-operated equipment can be sensitive to voltage spikes on the power leads, which can cause unexpected resets, strange behavior and/or permanent damage.

Vintage Air strives to harden our products against these types of electrical noise, but there is a point where a vehicle’s electrical system can be degraded so much that nothing can help.

Radio interference capacitors should be available at most auto and truck parts suppliers. They typically are cylindrical in shape, a little over an inch long and a little over a half-inch in diameter, and they have a single lead coming from one end of the cylinder with a terminal on the end of the wire, as well as a mounting clip which is screwed into a good ground on the vehicle. The specific value of the capacitance is not too significant in comparison to ignition capacitors that are matched with the coil to reduce pitting of the points.

- Care must be taken, when installing the compressor lead, not to short it to ground. The compressor lead must not be connected to a condenser fan or to any other auxiliary device. Shorting to ground or connecting to a condenser fan or any other auxiliary device may damage wiring or the compressor relay, and/or cause a malfunction.
- When installing ground leads on Gen 5 systems, the blower control ground and ECU ground must be connected directly to the negative battery post.
- For proper system operation, the heater control valve must be connected to the ECU.



www.vintageair.com

Engine Compartment Disassembly

NOTE: Before starting the installation, check the function of the vehicle (horn, lights, etc.) for proper operation, and study the instructions, illustrations, & diagrams. Retain the OEM bolts, washers and nuts, as some hardware will be reused.

Perform the Following:

1. Disconnect the battery.
2. Place a jack stand under the axle bar on the passenger side of the vehicle (See Photo 1, below), and remove the passenger side front tire.
3. Drain the radiator.
4. Remove the heater hoses at the firewall, the intake, and the water pump (discard) (See Photos 2 and 3, below).
5. From the engine compartment, remove the (3) OEM heater core mounting nuts from the firewall (See Photo 2, below).
6. Remove the radiator cooling fan by removing (4) bolts from the fan (See Photo 4, below)
7. Remove the OEM fan shroud by removing (4) bolts, ((2) on each side) (if equipped).

Place jack stand under axle bar

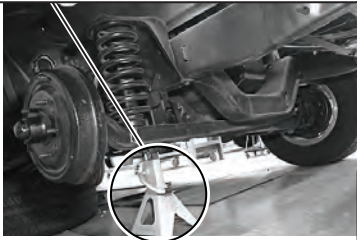
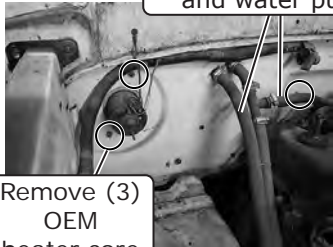

Photo 1

Remove heater hoses at firewall, intake, and water pump



Remove (3) OEM heater core mounting nuts from firewall

Photo 2

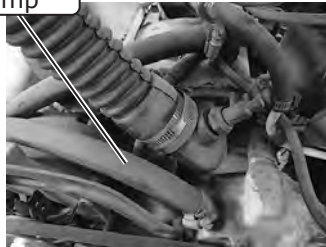

Photo 3

Remove radiator cooling fan by removing (4) bolts from fan

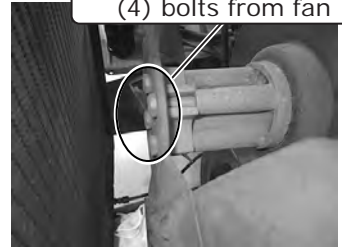

Photo 4

Passenger Compartment Disassembly

NOTE: Some OEM components that are not related to the A/C system will be temporarily removed to gain access to install new parts.

Perform the Following:

1. Remove (4) glove box door screws and (1) glove box door cable screw (See Photo 1, below), then remove the glove box door (discard glovebox).
2. Remove (4) glove box mounting screws and remove the glove box from the dash (discard) (See Photo 2, below).
3. Disconnect all plugs and cables from the heater/blower assembly (See Photo 3, below).
4. Disconnect the defrost boot from the heater/blower assembly and remove the blower assembly from the vehicle (discard) (See Photo 4, below).

Remove (4) glove box door screws and (1) glove box door cable screw

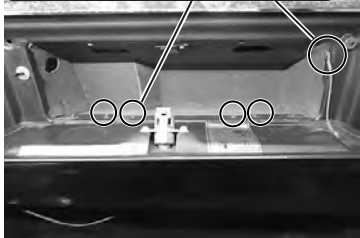

Photo 1

Remove (4) glove box mounting screws and remove glove box from dash

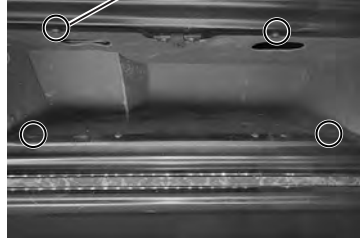

Photo 2

Disconnect all plugs and cables from heater/blower assembly



Photo 3

Disconnect defrost boot from heater/blower assembly and remove blower assembly



Photo 4

Passenger Compartment Disassembly (Cont.)

5. Remove (2) defrost duct plenum screws from the dash and remove the plenum from under the dash (See Photos 5 and 6, below).
6. Remove the radio knobs and mounting hardware, then the headlight and wiper knobs (See Photos 7 and 8, below).
7. Remove (5-7) gauge bezel screws (depending on model) (retain) (See Photo 9, below).
8. Disconnect the light for the headlight and wiper knobs, then remove the bezel from the vehicle (See Photo 10, below).
9. Remove (4) gauge cluster screws (retain). Unplug the wiring and speedometer connections from the back of the gauge cluster and remove it from the vehicle (See Photo 11, below).
10. Remove (4) control panel mounting screws (retain). Disconnect all the plugs, cables and the light, then remove the control panel from the vehicle (See Photo 12, below).
11. Remove (4) control panel/radio mounting bracket screws. Unplug the radio connections and remove the radio from the vehicle.
12. Remove (6) OEM fresh air duct mounting screws and remove the fresh air duct from the kick panel (See Photo 13, below).



Remove (2) defrost duct plenum screws from dash and remove plenum from under dash

Photo 5

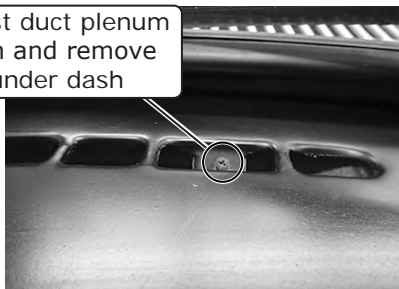

Photo 6



Remove radio knobs and mounting hardware

Photo 7



Remove headlight and wiper knobs

Photo 8



Remove (5-7) gauge bezel screws

Photo 9



Disconnect the light for headlight and wiper knobs, then remove bezel from vehicle

Photo 10

Remove (4) gauge cluster screws (retain), then unplug wiring and speedometer connections from back of cluster and remove it from vehicle

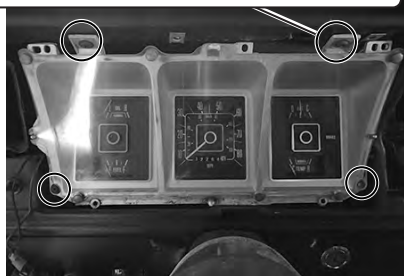

Photo 11

Remove (4) control panel mounting screws (retain). Disconnect all plugs, cables, and the light, then remove control panel from vehicle

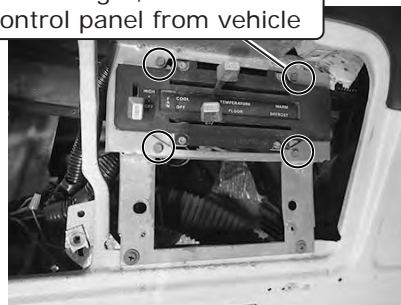

Photo 12

Remove (6) OEM fresh air duct mounting screws, and remove fresh air duct from kick panel



Photo 13



www.vintageair.com

Condenser Assembly and Installation

1. Refer to separate instructions included with the condenser kit to install the condenser.
2. Binary switch installation (Refer to condenser instructions).

Compressor and Brackets

1. Refer to separate instructions included with the bracket kit to install the compressor bracket.

Passenger Side Wheel Well Modification

1. Locate the passenger side inner fender kick panel grommet. Follow step "a" if there is a grommet and/or opening. Follow step "b" if the truck does not have a grommet and/or opening.
 - a. Remove the passenger side inner fender kick panel grommet (See Photo 1, below). Locate the firewall A/C hose cover plate and center it onto the passenger side inner fender kick panel opening. Using the cover plate as a template, mark and drill (2) 5/32" mounting holes (See Photo 2, below).
 - b. Locate the firewall A/C hose cover plate. Measure down from the body seam 4" (See Photos 3 and 4, below) and from the side body seam 1/2" (See Photo 5, below). Secure the cover plate in place as shown in Photo 6, below. Mark the (4) holes. The (2) mounting holes will be drilled using a 5/32" drillbit and the (2) A/C hose openings will be drilled to 1 1/4" (See Photo 7, below).

Remove passenger side inner fender kick panel grommet



Photo 1

Firewall A/C Hose Cover Plate 646990



Photo 2

Mark and drill (2) 5/32" mounting hole

Measure down 4" from body seam

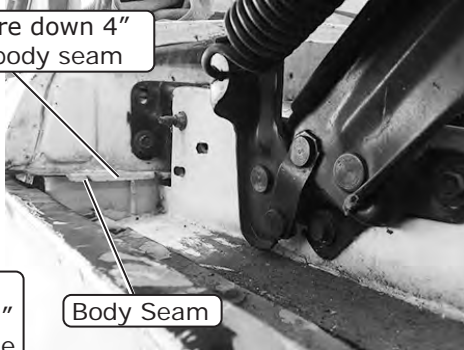

Photo 3

Body Seam

Measure down from body seam 4"

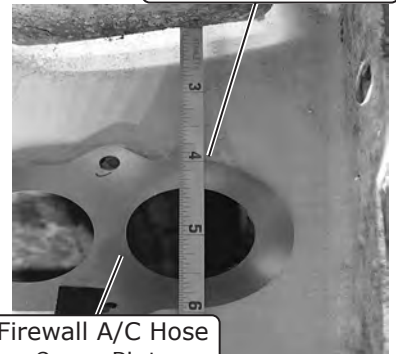

Photo 4

Firewall A/C Hose Cover Plate 646990

Measure 1/2" from side body seam

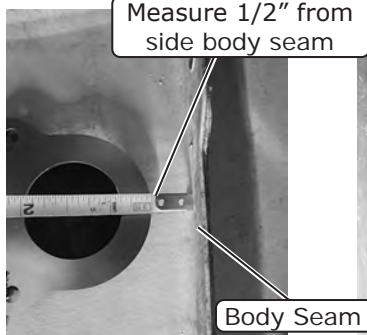

Photo 5

Body Seam

Secure A/C hose cover plate in place



Photo 6

Drill (2) 5/32" Mounting holes

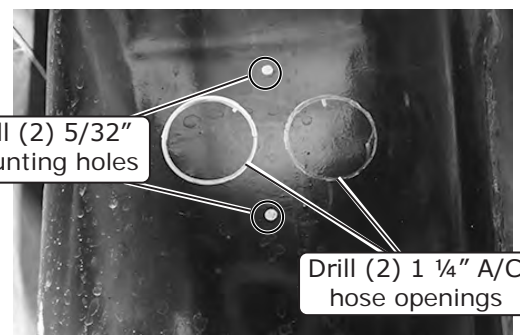

Photo 7

Drill (2) 1 1/4" A/C hose openings



www.vintageair.com

Engine Compartment, Passenger Side Inner Fender Modification

1. On the passenger side inner fender under the battery tray, locate a 3/4" OEM hole (See Photo 1, below). Enlarge the hole to 7/8" to accommodate the #10 A/C hose bulkhead fitting (See Photo 2, below).
2. Directly under the recently enlarged hole, measure from the middle of the hole 1 1/2" down, then mark and drill a 1" hole to accommodate the #6 A/C hose grommet (See Photos 2 and 3, below).



Engine Side

Photo 1

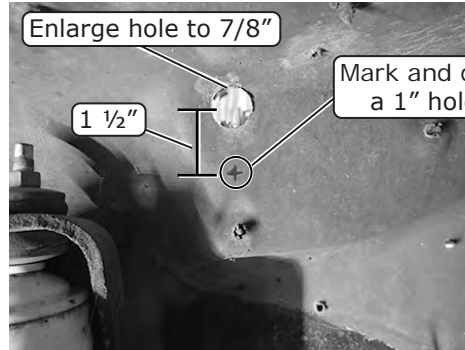

Wheel Well Side

Photo 2



Wheel Well Side

Photo 3

Firewall Modification

1. From the passenger compartment, measure from the passenger side kick panel 15 3/8" towards the driver side and 2 1/2" up from the floor seam (See Photo 1, below). Mark and drill a 5/8" hole for the drain tube grommet (See Photo 1, below). **NOTE: To ensure a tight fit for the drain hose, do not enlarge the hole to more than 5/8".**
2. Install (2) 1" plugs into the OEM heater hardline holes in the firewall (See Photo 2, below).

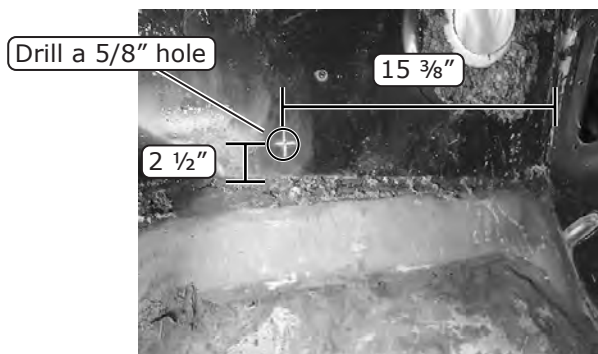

Photo 1

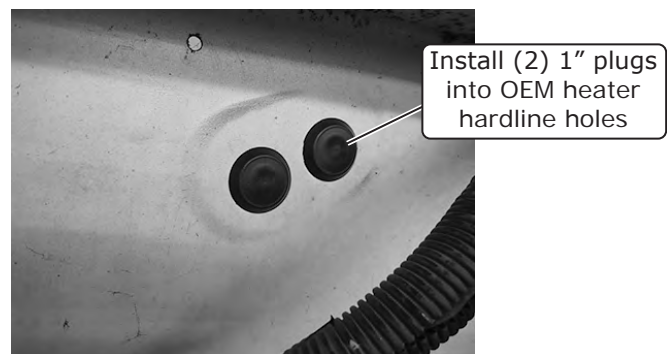

Photo 2



www.vintageair.com

Dash Modification

1. Using the template provided in the kit, align the template for the dual center and passenger side louvers with the arrow facing up as shown in Photo 1 below.
2. Mark the louver openings and cut out the dash (See Photos 2 and 3, below). **NOTE: Before cutting the dash, ensure the marks are the same size as the template openings.**
3. Align the driver side template in the gauge cluster bezel as shown in Photo 4, below. Drill the pilot holes using a 5/64" drill bit.
4. Flip the bezel over and realign the template over the drilled holes, then mark the square (See Photo 5, below).
5. Cut and remove the marked area (See Photo 6, below).
6. **Optional-** Flip the bezel over to the front side and remove the remaining plastic trim so the louver sits flush to the bezel (See Photo 7, below).
7. Install the driver side louver into the bezel opening and secure it using (4) #4 x 1/2" screws (See Photo 8, below).

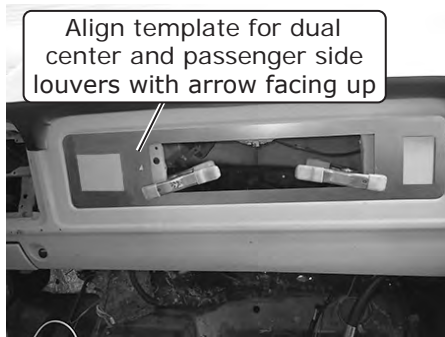

Photo 1

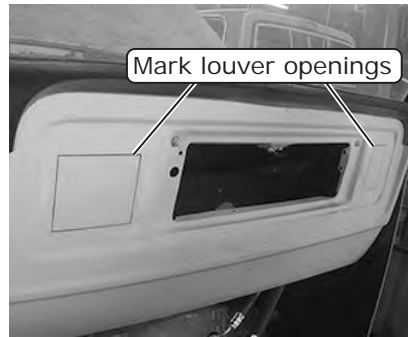

Photo 2



Photo 3

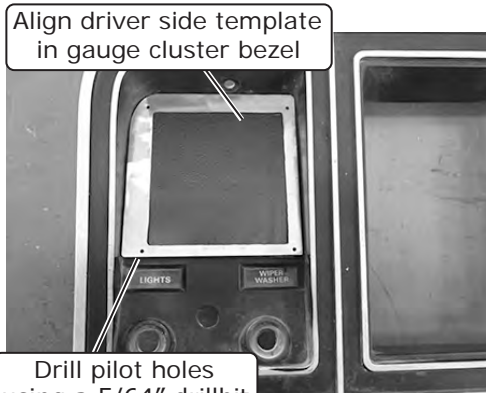

Photo 4

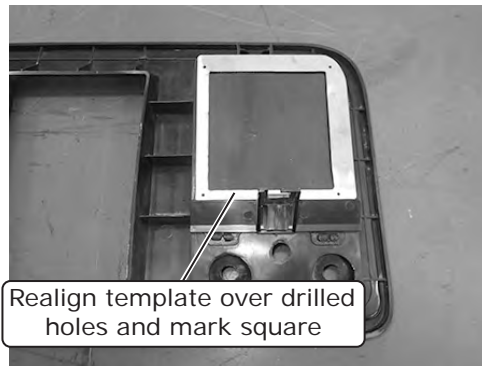

Photo 5

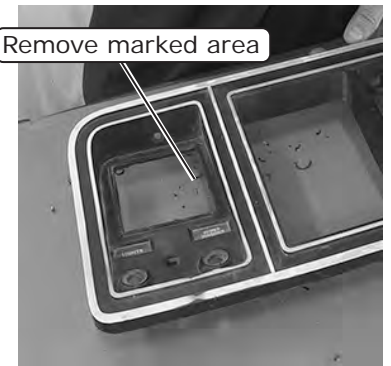

Photo 6



Optional

Photo 7

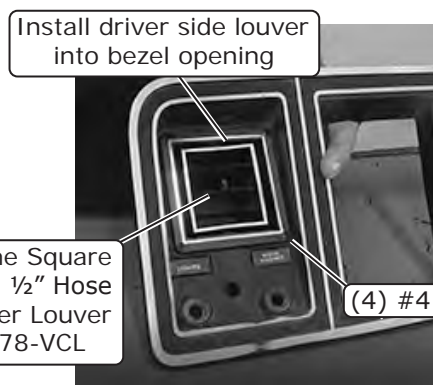

Photo 8



www.vintageair.com

Defrost Duct Installation

1. On the driver side defrost duct, install a #8 U-nut onto the left side of the defrost bracket as shown in Photo 1, below.
2. On the passenger side defrost duct, install a #8 U-nut onto the right side of the defrost bracket as shown in Photo 2, below.
3. Attach a piece of duct hose on each defrost duct, lengths shown on Duct Hose Routing, Page XX. Once the evaporator module is installed there will be limited space to connect the duct hoses.
4. Install the driver- and passenger-side defrost ducts, and secure them using (2) ((1) per side) #8 x 1" screws in the OEM defrost mounting holes (See Photo 3, below).

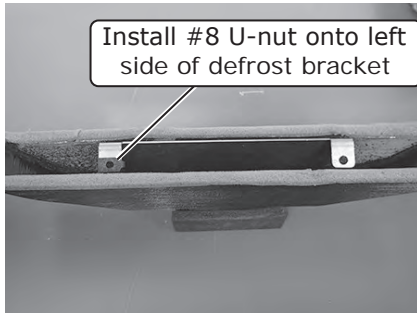

Driver-Side Defrost Duct

Photo 1

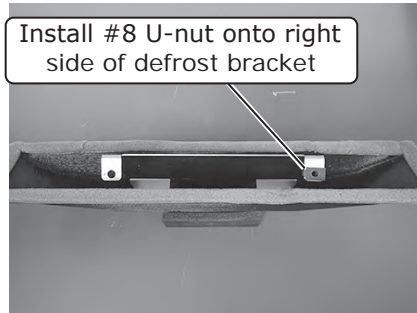

Passenger-Side Defrost Duct

Photo 2

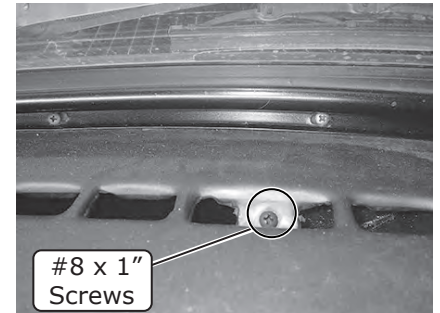

#8 x 1" Screws

Photo 3

Center and Passenger-Side Louver Installation

1. Locate the (3) louvers and remove the louvers from the louver housing. **NOTE: To remove the louver from the louver housing, push the louver forward until it unlocks (See Photos 1 and 2, below). Be sure not to push the louver from the deflectors. Push from the louver frame to avoid breaking the mechanism (See Photo 2, below). Do this on both sides of the louver, then press the pivot on one end and remove the louver from the housing (See Photos 3, 4 and 5, below).**

Chrome Rectangle with 2 1/2" Hose Adapter Louver 491790

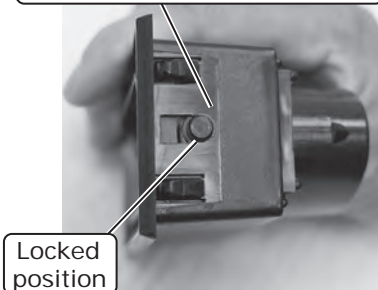

Locked position

Photo 1

Push louver forward until it unlocks

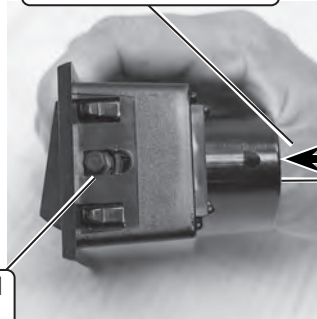

Unlocked position

Photo 2

Push from louver frame

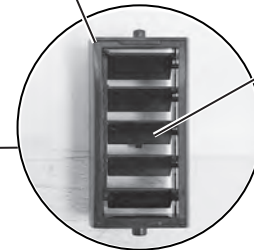

DO NOT push from deflectors

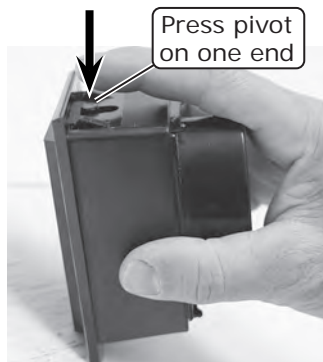

Press pivot on one end

Photo 3

Remove louver from housing



Photo 4

Louver removed from housing



Photo 5



www.vintageair.com

Center and Passenger-Side Louver Installation (Cont.)

2. Install the louver housings into the previously modified dash openings. **NOTE: Before installing the louver housings, make sure all the housings are aligned/oriented with the larger opening for the louver pivot at the bottom of the dash. If the louver housings are loose in the dash openings, apply silicone to the mating surface of the housings, then install and let dry.**
3. Reinstall the louvers into the housings by pressing on the pivots, then push the louver into the housing from the frame to fully secure (See Photos 6 and 7, below).



(2) Chrome Rectangle with 2 1/2" Hose Adapter Louver 491790

Photo 6

Photo 7

Chrome Rectangle with 2 1/2" Hose Adapter Louver 491790

Lubricating O-rings

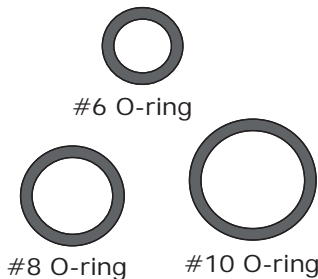

NOTE: Standard torque specifications:
 #6: 11 to 13 ft-lb.
 #8: 15 to 20 ft-lb.
 #10: 21 to 27 ft-lb.

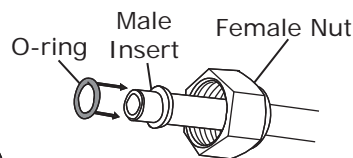

For a proper seal of fittings: Install supplied O-rings as shown and lubricate with refrigerant oil.

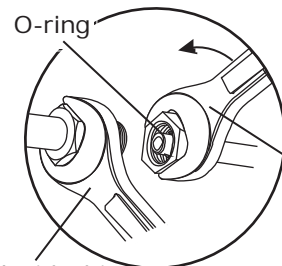
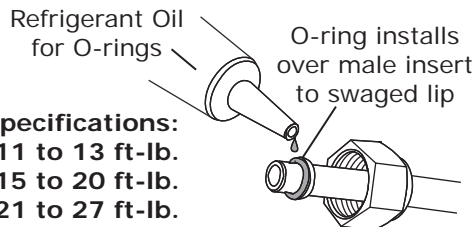

Hold with this wrench

Twist with this wrench

Properly Seated O-ring Land

When installing a hardline or A/C hose fitting onto the evaporator module, ensure the O-ring land is seated properly (See Photo 1, below). An improperly seated O-ring land (See Photo 2, below) can cause a leak. To properly install the fitting, slide the hardline or A/C hose nut back to expose the O-ring land and seat it onto the evaporator module fitting. Then, slide the hardline or A/C hose nut forward and thread it onto the evaporator module fitting, ensuring the O-ring land does not move or lift.

Properly Seated O-ring Land



Photo 1

Improperly Seated O-ring Land



Photo 2

NOTE: Photos shown are for reference only. Fittings may vary depending on kit received.



www.vintageair.com

Evaporator Preparation

On a workbench, perform the following:

1. Install a plastic cap as shown in Photo 1, below.
2. Install the floor plenum using (2) spring clips (See Figure 1 and Photo 2, below).
3. Install the dash plenum using (4) spring clips (See Figure 2 and Photo 3, below).

NOTE: Do not install the third plenum for the defrost yet, this will be installed once the unit is mounted behind the dash, there is limited space, and this plenum may interfere.

4. Install the (2) hardlines as shown in Figure 3, below, with (2) properly lubricated #10 O-rings (See Lubricating O-rings, Page 12), do not fully tighten, they will get adjusted in the next steps.
5. Install (2) well nuts next to the floor plenum (See Figure 3, below).
6. Install the driver-side evaporator bracket using (2) 1/4-20 x 1" serrated flange bolts (See Figure 4, below).

Install a plastic cap

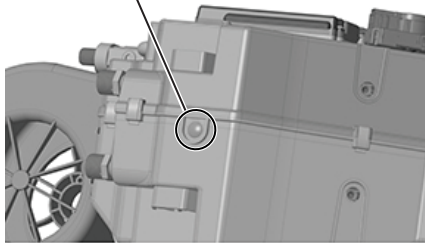
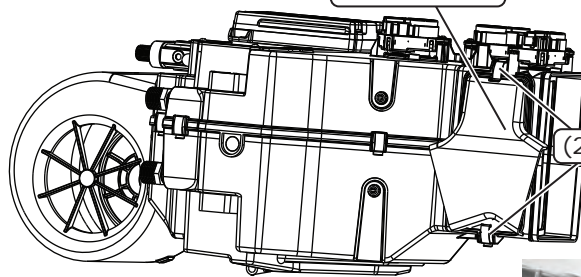

Photo 1

Floor Plenum
625338



(2) Spring Clips

Using (2) spring clips, install floor plenum

Figure 1

Dash Plenum
625330

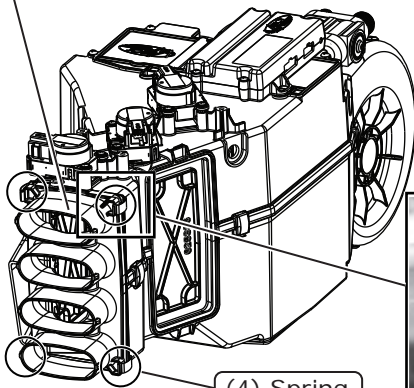

(4) Spring Clips

Figure 2

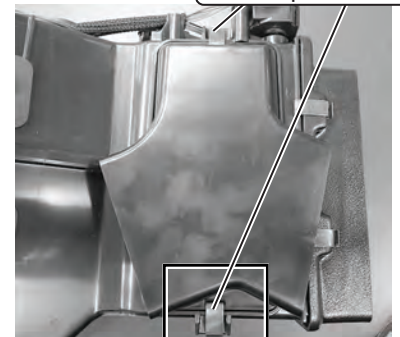

Photo 2



Spring Clip Installed

Photo 3

Upper Heater Hardline
082083

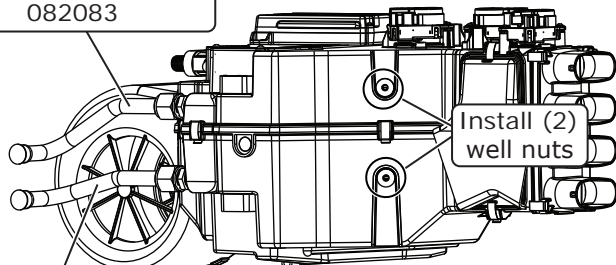

Install (2) well nuts

Lower Heater Hardline
082084

Figure 3

(2) 1/4-20 x 1" Serrated Flange Bolts

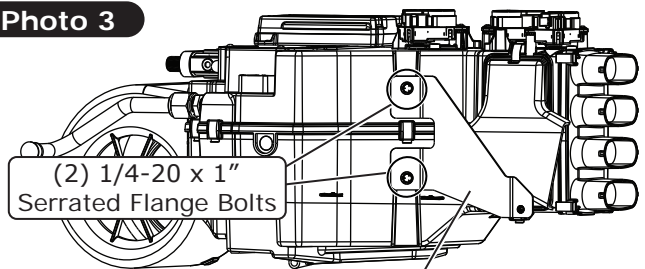

Install evaporator firewall driver-side bracket
646995

Figure 4



www.vintageair.com

Evaporator Preparation (Cont.)

7. Install the passenger-side bracket using (4) #10 x 5/8" screws (See Figure 5, below).
8. Install (2) 1/4-20 x 1 1/2" full-threaded studs, (1) on the top mounting hole of the passenger-side bracket and (1) on the driver-side bracket (See Figure 6, below). Thread the studs halfway in. **NOTE: If the studs are sticking out too far, it may cause interference issues when mounting the unit under the dash due to the tight clearance.**
9. Temporarily place the firewall cover on top of the evaporator brackets, using the studs to align it, then center the hardlines into the firewall cover holes (See Figure 7, below). Once the hardlines are centered, remove the firewall cover, and tighten the hardlines. **NOTE: For additional clearance, when tightening hardlines, the evaporator bracket can be temporarily removed.**
10. Locate the evaporator dash bracket and install (2) #8 U-nuts as shown in Photo 4, below. **NOTE: Do not install the dash bracket at this time.**

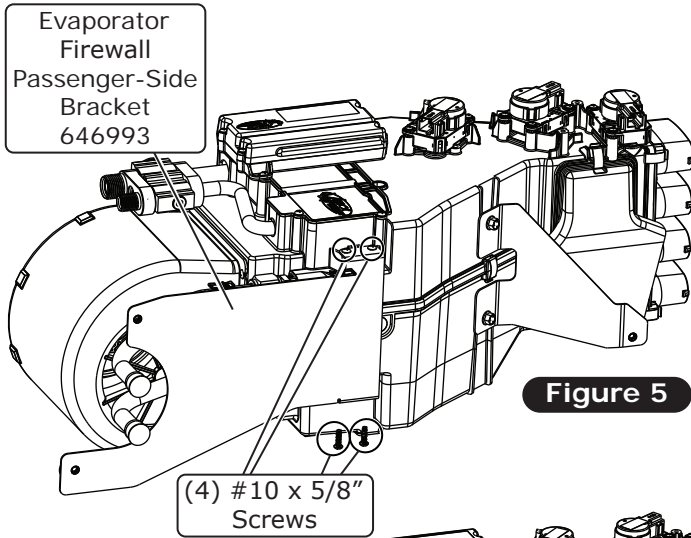

Figure 5

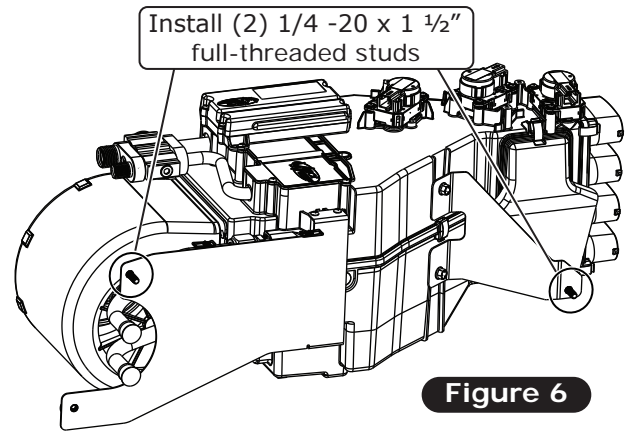

Figure 6

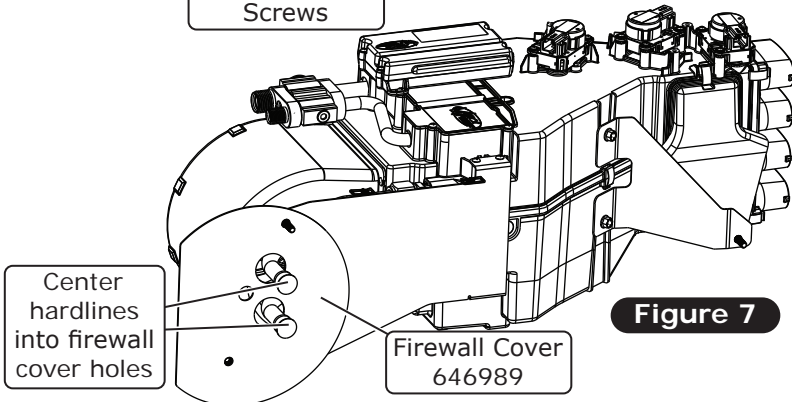

Figure 7

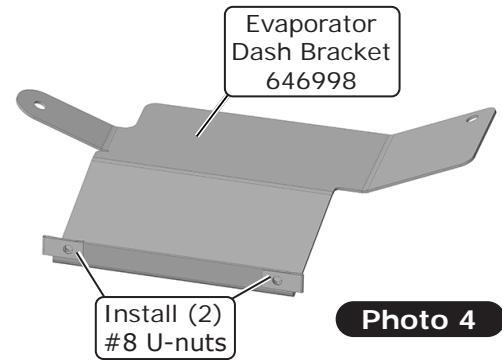

Photo 4

Firewall Insulation

NOTE: For proper operation of the evaporator unit, Vintage Air recommends using heat-blocking insulation in the area around the subcase (firewall, inner cowl and kick panel). Due to tight clearance for the evaporator unit between the firewall and dash, Vintage Air recommends an insulation thickness of no more than 1/4".

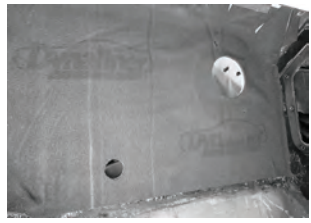

Photo 1

Insulation Installed



www.vintageair.com

A/C Hose Routing & Kick Panel Cover Installation

NOTE: Soapy water may be used to ease insertion of the A/C hoses through the grommets, but be sure the hoses are capped to prevent water from getting inside.

1. Locate the #10 evaporator/fenderwell A/C hose, and install the end of the hose with the 90° fitting through the inner fenderwell (See Photo 1, below). **NOTE: The 90° bulkhead fitting will restrict the A/C hose from going through the inner fenderwell.**
2. Locate the 1 ¼" grommet and install it into the inner fenderwell under the #10 bulkhead fitting (See Photo 2, below).
3. Locate the #6 drier/evaporator A/C hose and route the straight fitting from under the fenderwell through the grommet into the engine compartment (See Photo 3, below). **NOTE: Ensure that the straight fitting reaches the drier connection.**
4. Secure the #10 and #6 A/C hoses to the core support using the #10 and #6 Adel clamps with #10 x 1/2" sheet metal screws (See Photo 4, below).
5. Route the (2) A/C hoses into the channel on the inner fender, and install an A/C hose fenderwell bracket onto the OEM bolt using a 5/16-18 hex nut (See Photo 5, below).
6. Locate the firewall A/C hose cover plate and rubber boot (See Photo 6, below).

#10 Evaporator/
Fenderwell A/C Hose
082085

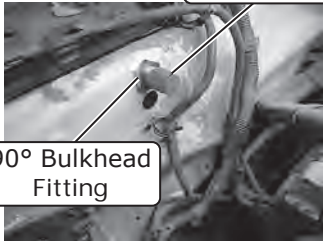

90° Bulkhead Fitting

Photo 1



1 ¼" Grommet

Photo 2

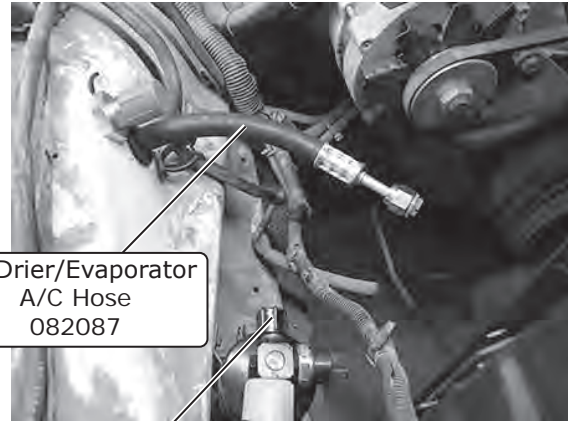

#6 Drier/Evaporator
A/C Hose
082087

Drier Connection

Photo 3

A/C Hose
Fenderwell Bracket
646967

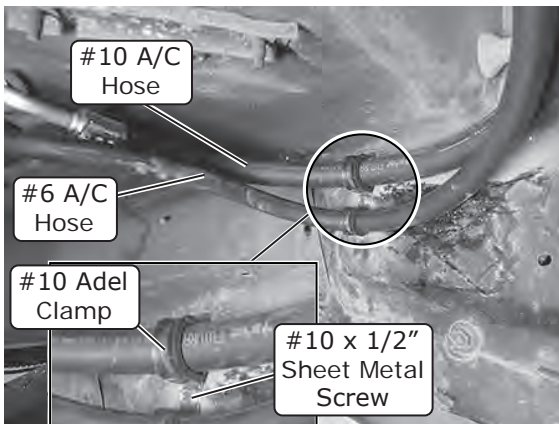

#10 A/C
Hose

#6 A/C
Hose

#10 Adel
Clamp

#10 x 1/2"
Sheet Metal
Screw

#6 Adel
Clamp

Photo 4



5/16-18 Hex Nut

Photo 5

Inner Fender
Rubber Boot
338637



Inner Fender
Cover Plate
646990

Photo 6



www.vintageair.com

A/C Hose Routing & Kick Panel Cover Installation (Cont.)

7. Route the #10 A/C hose 45° fitting through the firewall A/C hoses cover plate, and through the large hole in the rubber boot (See Photo 7, below).
8. Route the #6 A/C hose 45° fitting through the firewall cover plate and rubber boot (See Photo 8, below).
9. Route the #6 and #10 A/C hoses through the kick panel opening into the passenger compartment.
10. Install an A/C hose fenderwell bracket using a 1/4-20 x 1/2" hex bolt and 1/4-20 nut with star washer through the OEM hole on the inner fender (See Photo 9, below).
11. Secure the rubber boot and firewall cover plate to the firewall using (2) #10 x 1/2" sheet metal screws into the previously drilled 5/32" holes in the inner fender kick panel grommet location (See Photo 9, below).
12. Locate the kick panel cap and install (2) large grommets (See Photo 10, below). **NOTE: Verify the correct side of the grommet is installed.**

Route #10 A/C hose 45° fitting through firewall cover plate, and large hole in rubber boot



Photo 7

Route #6 A/C hose 45° fitting through firewall cover plate and rubber boot



Photo 8

1/4-20 Hex Nut with Star Washer

1/4-20 x 1/2" Hex Bolt

A/C Hose Fenderwell Bracket 646967

(2) #10 x 1/2" Sheet Metal Screw

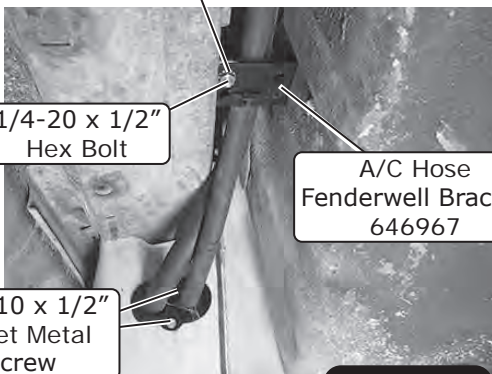

Photo 9

1 1/4" O.D. Grommet 33133-VUI

Large Grommet 33137-VUI

Kick Panel Cover 647109

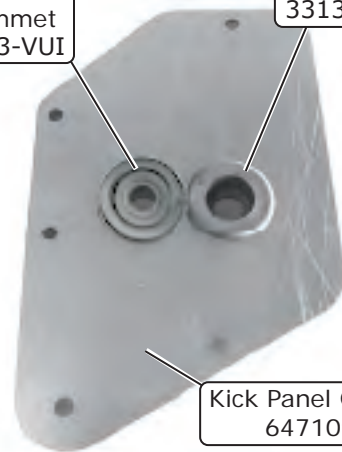

Photo 10



www.vintageair.com

A/C Hose Routing & Kick Panel Cover Installation (Final)

13. Route the #10 evaporator/fenderwell A/C hose 45° fitting through the right side grommet in the kick panel cover (See Photo 11, below).
14. Route the #6 drier/evaporator A/C hose 45° fitting through the left side kick panel grommet (See Photo 12, below). **NOTE: Be sure that the 45° fitting is facing up as shown in Photo 12, below.**
15. Apply silicone around the kick panel cover mating surface for a watertight seal (See Photo 13, below).
16. Install the kick panel cover onto the kick panel opening, and secure it using (5) #14 x 3/4" washer head screws (See Photo 14, below). **NOTE: The last screw will be installed later with the relay.**
17. Secure the A/C hoses to the fenderwell brackets using the supplied tie wraps (See Photos 15 and 16, below).

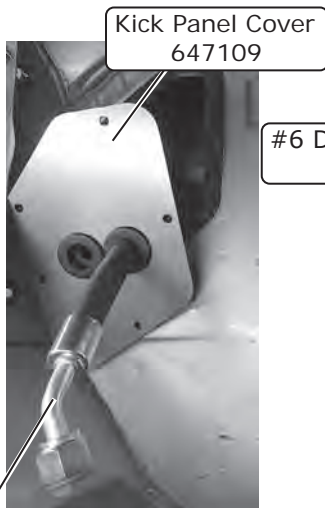

Photo 11

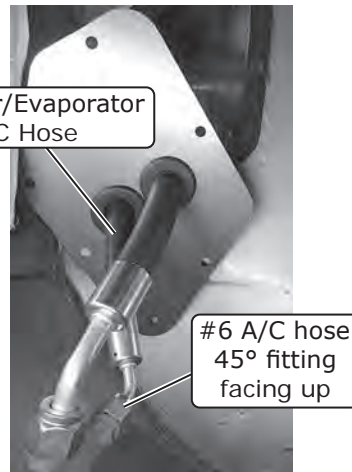

Photo 12

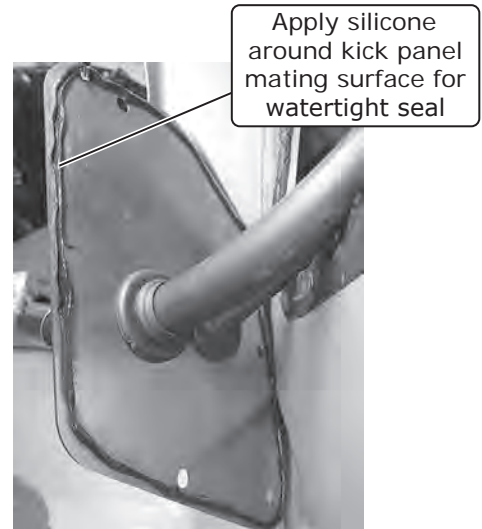

Photo 13

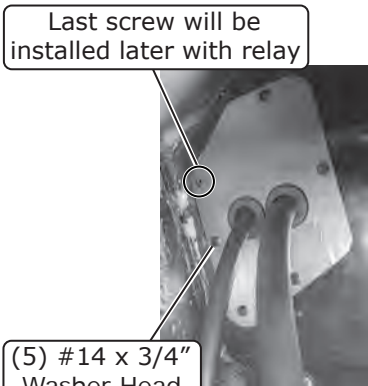

Photo 14



Photo 15



Photo 16



www.vintageair.com

Evaporator Installation

NOTE: A board cut approximately to 12 1/4" must be used between the firewall and the dash to provide space to install the evaporator module (See Photo 1, below).

1. Remove the (2) dash mounting bolts ((1) in the center of lower dash (See Photo 2, below), and (1) on the passenger side in the upper right corner next to the kick panel opening (See Photo 3, below)). **NOTE: This will be necessary to provide extra space when installing the evaporator module.**
2. Place the evaporator module on the passenger floorboard, and with a properly lubricated #6 O-ring (See Lubricating O-rings, Page 12), install the 45° fitting to the block valve adapter of the evaporator module oriented as shown in Photo 4, below.
3. The ECU must be removed from the evaporator module. Loosen the (2) screws securing the ECU (See Photo 5, below), slide the ECU to the side and remove it (See Photos 6 and 7, below). Very carefully remove the tie wraps securing the ECU harness. The ECU will be relocated under the dash once the evaporator is installed. Secure the (2) screws that were loosened on top of the evaporator module. **NOTE: Do not disconnect the ECU wires, leave the ECU hanging.**
4. Raise the evaporator module under the dash straight up, inserting the studs and hardlines through the firewall (See Photos 8 and 9, below). **NOTE: Look at the heater hardlines through the glove box opening to make sure they clear any protrusion on the firewall. Removal of the OEM insulation is necessary, See the Firewall Insulation information on Page 14.**

12 1/4" Board



Photo 1

Remove (2) dash mounting bolts

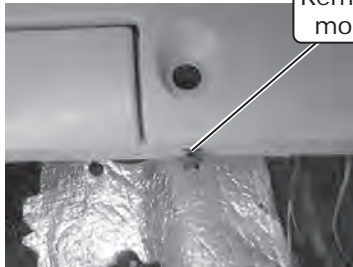

Photo 2



Photo 3

Place evaporator module on passenger floorboard

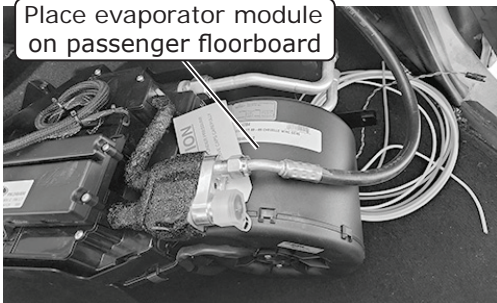

Photo 4

Loosen (2) screws securing ECU

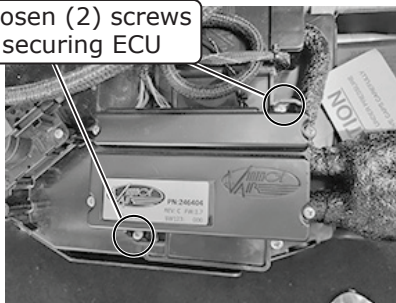

Photo 5

Slide ECU to side and remove it

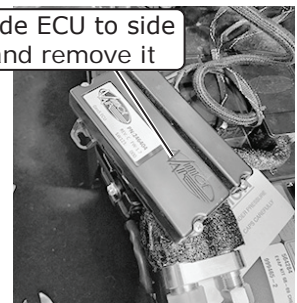
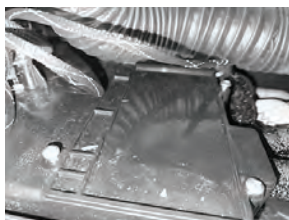

Photo 6



ECU Removed

Photo 7

Raise evaporator module under dash straight up



Photo 8



Photo 9



www.vintageair.com

Evaporator Installation (Cont.)

5. Install (2) well nuts on the evaporator module as shown in Figure 1, below.
6. Remove the support board and install the evaporator dash bracket onto the evaporator module as shown in Figure 2, below, using (2) 1/4-20 x 1" serrated flange bolts.
7. Install the defrost plenum using (2) spring clips (See Photos 10 and 11, below).
8. Level the evaporator module as shown in Photo 12, below. **NOTE: To ensure proper drainage, it is very important that the evaporator is level, both left-right and fore-aft. Before leveling the evaporator, ensure the vehicle is level. Depending on the vehicle, there may be clearance issues where a standard size level doesn't fit. The use of a compact level may be needed.**
9. Use the template provided against the evaporator unit to mark the bottom of the dash (See Photo 13, below). The template must be oriented properly with the "blower" on the top and the arrow pointing to the evaporator blower as shown in Photo 14, below.

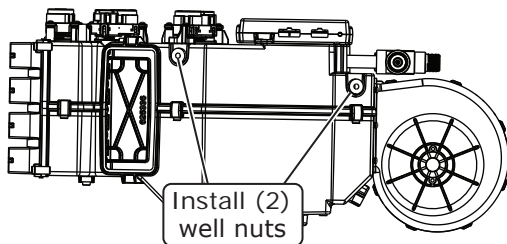
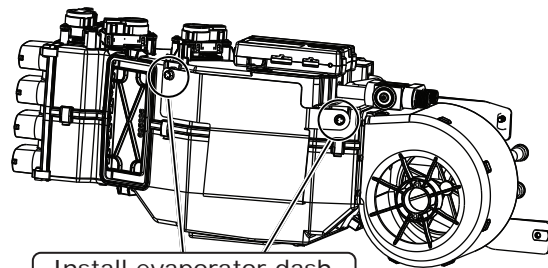

Figure 1



Install evaporator dash bracket using (2) 1/4-20 x 1" serrated flange bolts

Figure 2

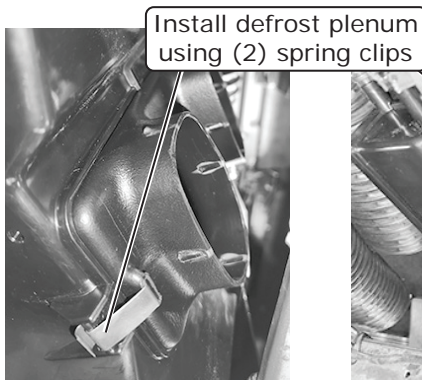

Photo 10

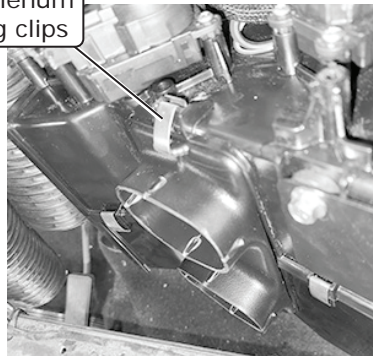

Photo 11

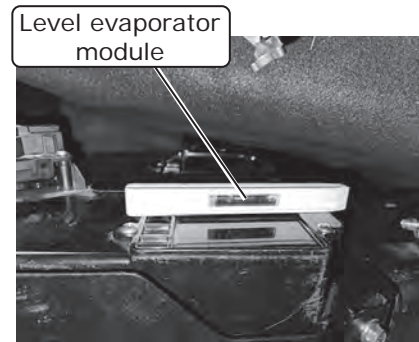
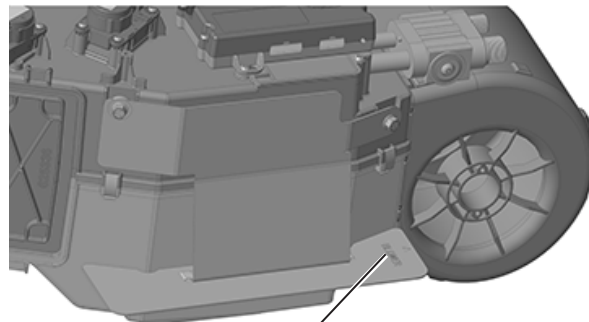

Photo 12



Photo 13



Template must be oriented properly with "blower" on top and arrow pointing to evaporator blower

Photo 14

Evaporator Installation (Final)

10. Drill (2) 11/64" holes (See Photo 15, below).
11. Install (2) #8 x 1/2" screws through the lower dash into the evaporator dash bracket (See Photo 16, below).
12. Install (2) large grommets into the openings on the firewall cover. **NOTE: Verify the correct side of grommet is installed as shown in Photo 17, below.**
13. Apply a bead of silicone around the mating surface of the firewall cover (See Photo 18, below), and install it over the full-length studs and heater hardlines (See Photo 19, below).
14. From the engine compartment, replace the full-length studs with (3) 1/4-20 x 3/4" hex washer bolts ((2) on the passenger side firewall cover (See Photo 20, below), and (1) on the driver side evaporator bracket) (See Photo 21, below). **NOTE: Confirm the evaporator module stays leveled when tightening hardware.**

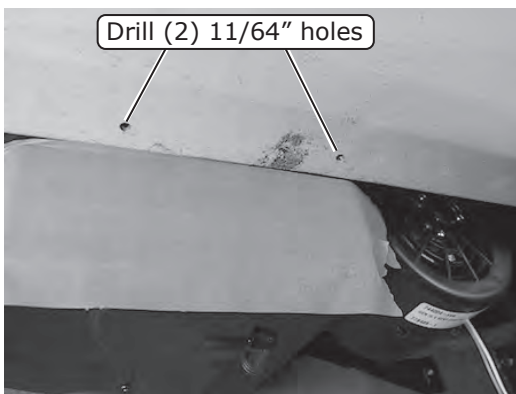

Photo 15

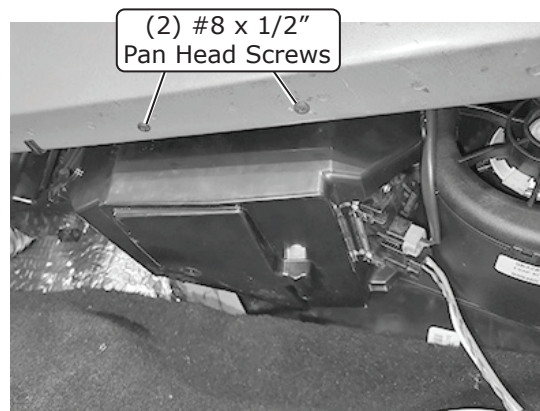

Photo 16

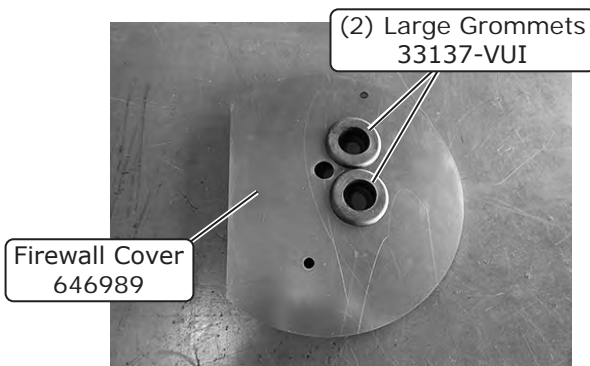

Photo 17

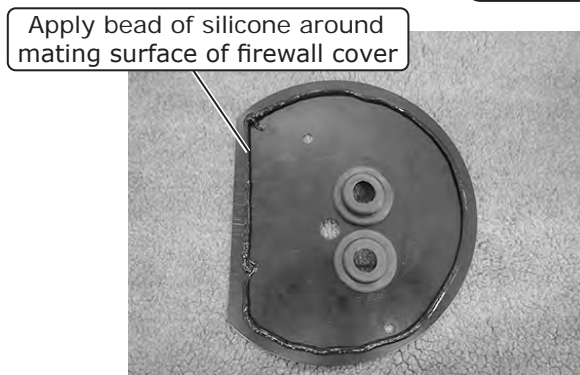

Photo 18



Photo 19

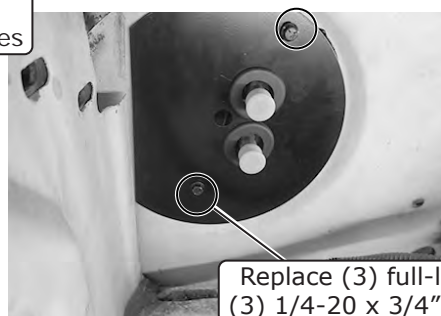

Photo 20

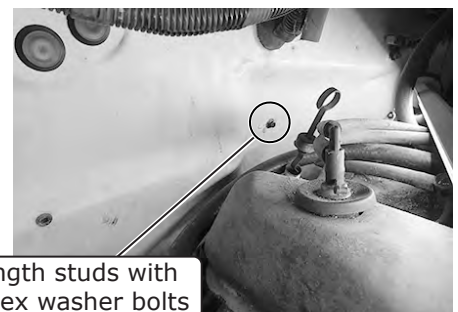

Photo 21



www.vintageair.com

A/C Hose Installation

1. Install the 45° fitting of the #10 evaporator/fenderwell A/C hose to the block valve adapter with a properly lubricated #10 O-ring (See Lubricating O-rings, Page 12, and Photo 1, below).
2. Insulate the #10 evaporator fitting and all exposed metal with the supplied press tape (See Photo 2, below).
3. Using a properly lubricated #6 O-ring (See Lubricating O-rings, Page 12), connect the straight fitting of the #6 drier/evaporator A/C hose to the drier (See Photo 3, below).
4. Using a properly lubricated #10 O-ring (See Lubricating O-rings, Page 12), connect the 135° fitting with service port of the #10 fenderwell/compressor A/C hose to the #10 suction port on the compressor (See Photo 4, below).
5. Using a properly lubricated #10 O-ring (See Lubricating O-rings, Page 12), connect the 45° fitting of the #10 fenderwell/compressor A/C hose to the #10 bulkhead fitting (See Photo 5, below).
6. Using a properly lubricated #8 O-ring (See Lubricating O-rings, Page 12), connect the #8 condenser/compressor A/C hose 90° fitting with service port to the #8 discharge port on the compressor (See Photo 6, below).
7. Using a properly lubricated #8 O-ring (See Lubricating O-rings, Page 12), connect the #8 A/C hose straight fitting to the #8 condenser hardline (See Photo 7, below).

Install 45° fitting of #10 A/C hose to block valve adapter

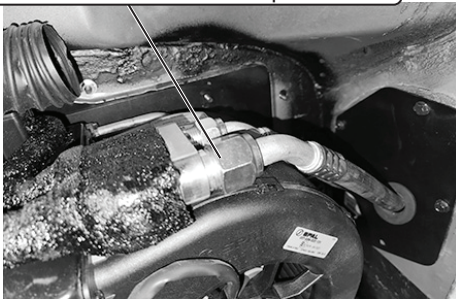

Photo 1

Insulate all exposed metal with supplied press tape

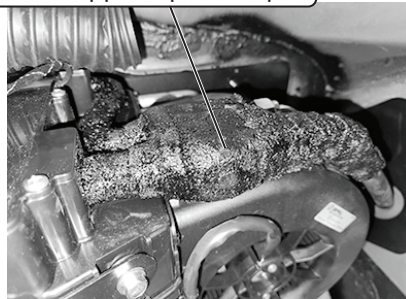

Photo 2

Connect straight fitting of #6 A/C hose to drier

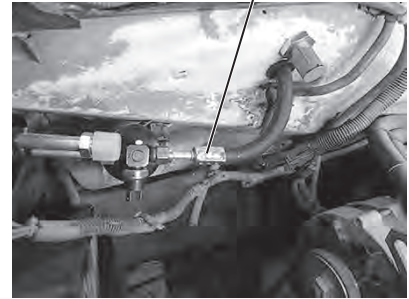

Photo 3

Connect 135° fitting with service port of #10 A/C hose to compressor

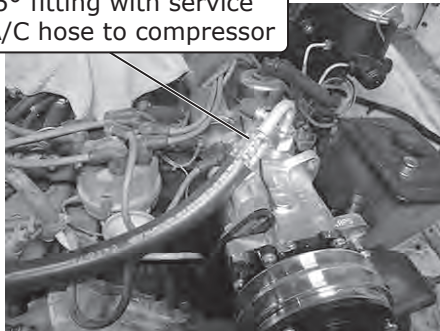

Photo 4

Connect 45° fitting of #10 A/C hose to #10 bulkhead fitting

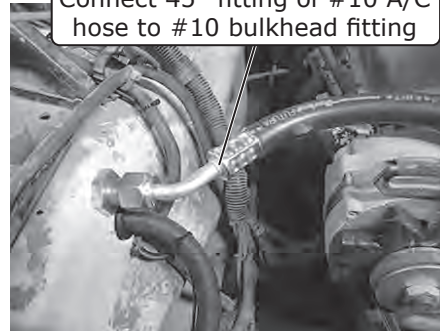

Photo 5

Connect #8 A/C hose 90° fitting with service port to compressor

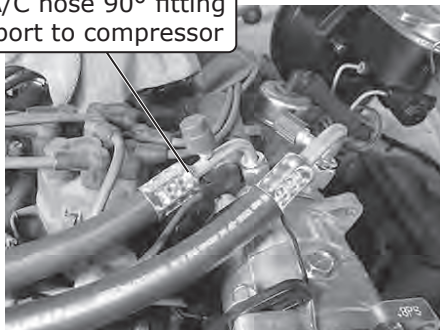

Photo 6

Connect #8 A/C hose straight fitting to #8 condenser hardline



Photo 7



www.vintageair.com

Heater Hose & Heater Control Valve Installation

NOTE: Vintage Air systems use 5/8" connections. On engines equipped with 3/4" hose nipples, these will need to be removed and replaced with 5/8" nipples (not supplied). For water pumps with cast-in 3/4" heater outlet, a 3/4" x 5/8" reducer fitting (not supplied) or molded hose (Vintage Air part #099010) will need to be installed in the heater hose.

1. Remove the caps from the heater hardlines.
2. Route a piece of heater hose (not supplied) from the lower heater hardline to the water pump and secure the hose using (2) #12 hose clamps (See Photo 1, below).
3. Install a 5" piece of heater hose to the heater control valve and install it to the upper heater hardline, then secure it using (2) #12 hose clamps (See Photo 1, below). **NOTE: Ensure proper flow direction through the heater control valve (the flow direction follows the molded arrow on the valve)** (See Figure 1 and Photo 2, below).
4. Install a length of heater hose (not supplied) from the heater control valve to the intake manifold fitting. Secure the hose with (2) #12 hose clamps (See Photo 1, below).

Install 5" piece of heater hose to heater control valve and install to upper heater hardline, secure using (2) #12 hose clamps

Route piece of heater hose from lower heater hardline to water pump and secure hose using (2) #12 hose clamps

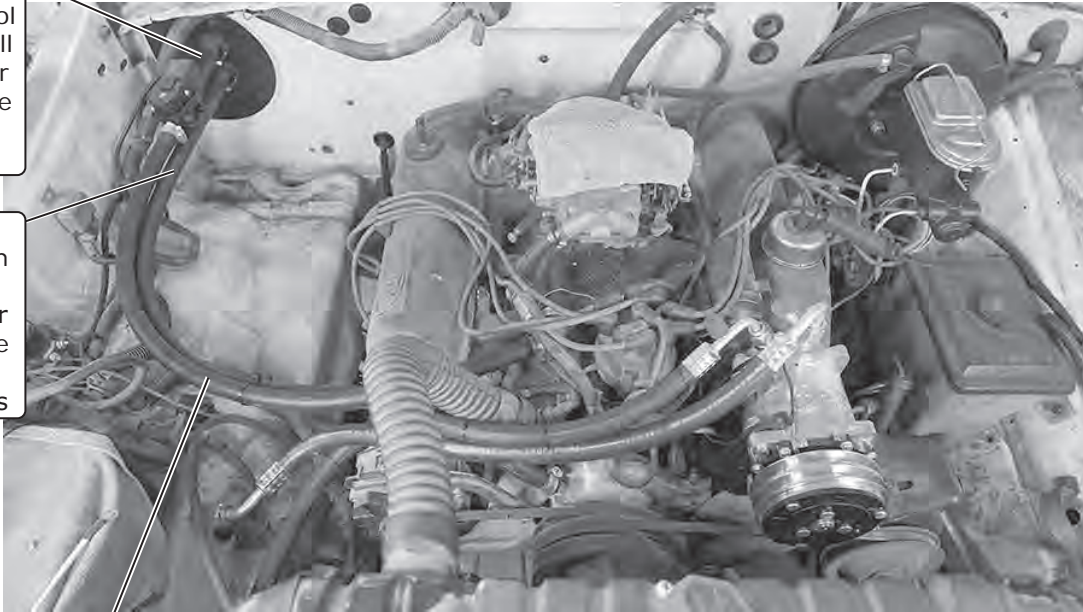
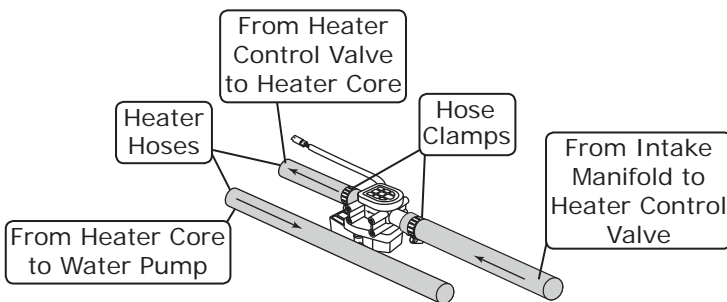

Photo 1

Install a length of heater hose from heater control valve to intake manifold fitting. Secure hose with (2) #12 hose clamps



NOTE: Flow Direction Follows Molded Arrow on Valve.

Figure 1

Heater Control Valve 461171

Attach 5" Piece of Heater Hose

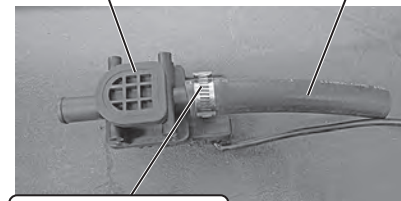

#12 Hose Clamp

Photo 2



www.vintageair.com

Drain Hose Installation

1. Cut the supplied drain hose to 9" long, and install the 1/2" drain elbow, then attach the remainder of the drain hose to the other end as shown in Photo 1, below.
2. Install the drain hose through the previously drilled 5/8" hole on the firewall, then onto the evaporator drain (See Photos 2 and 3, below). **NOTE: The 9" piece of hose attaches to the drain on the evaporator.**

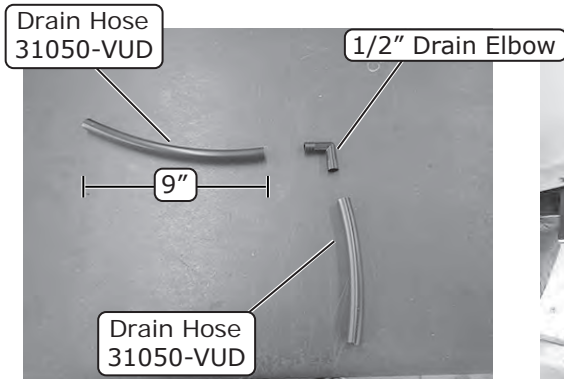

Photo 1

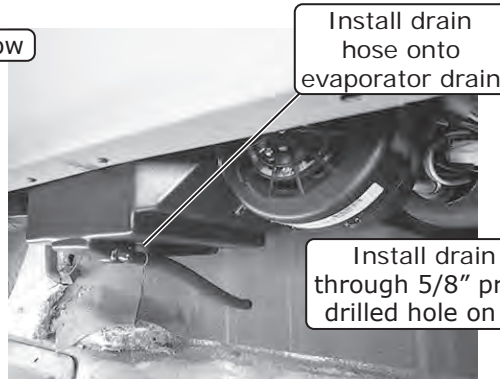

Photo 2

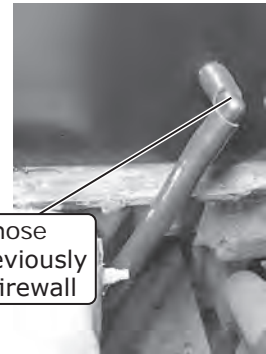

Photo 3



www.vintageair.com

Duct Hose Routing

NOTE: For the system to function optimally, the duct hoses must be routed as directly as possible, taking care to avoid kinks, sharp bends and unnecessary length. Vintage Air supplies duct hoses in continuous lengths that will need to be cut to size depending on application. Before cutting, familiarize yourself with the installation instructions and verify the routing will work with your application. For custom hose routing, additional hose may be needed and can be purchased from Vintage Air.

1. Stretch the duct hose until there is no slack, measure, mark and cut hose to size (See Photo 1, below).

Stretch, measure, mark and cut hose to size



Photo 1

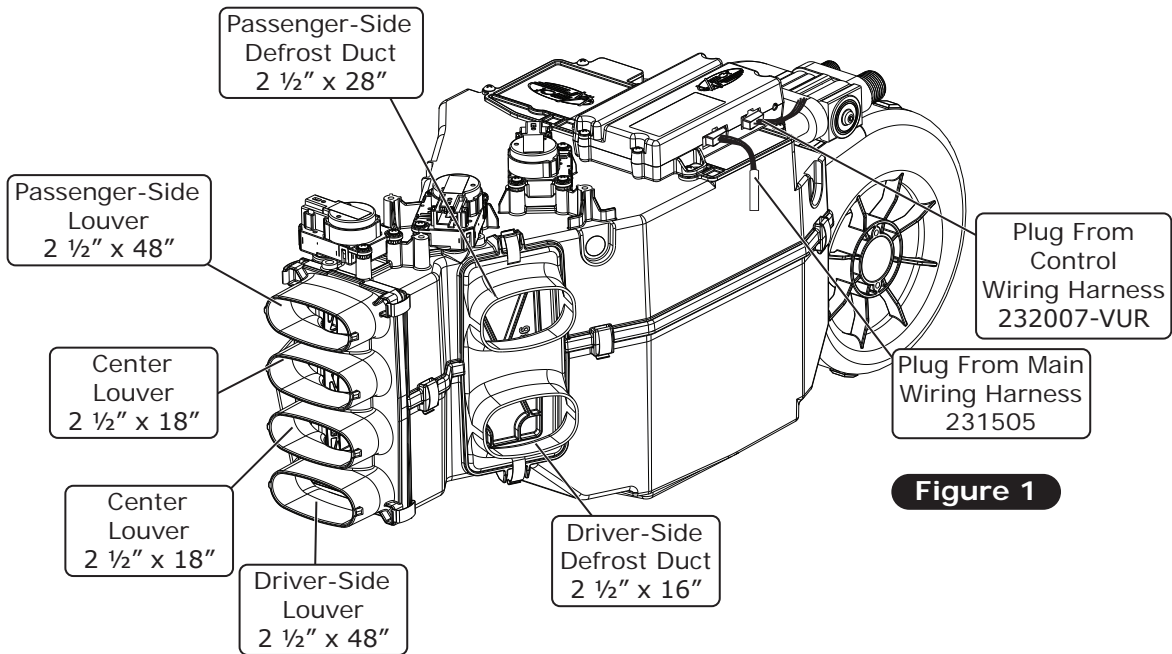

Figure 1

NOTE: Route wires so they are lower than plugs.



Route wires lower than plugs

NOTE: ECU must be placed away from water and humidity, and also be accessible for servicing. If relocating, connectors must be positioned towards the bottom.



Position connectors towards bottom



www.vintageair.com

Wiring Installation

NOTE: The heater hoses are shown on the following pictures below. To ease the wiring process, the heater hoses must be installed after routing all the wires through the wiring hole (heater hose installation shown on Page 22).

1. Locate the heater control valve plug on the main wiring harness (white/yellow/purple) (See Photo 1, below). Route it through the wiring opening hole on the firewall cover and into the engine compartment (See Photo 1, below).
2. Install a 5/8" grommet over the heater control valve plug and install on the firewall cover (See Photo 2, below).
3. Plug the heater control valve connector to the main wiring harness (See Photo 3, below).
4. Route the red, white, and blue wires from the main wiring harness through the 5/8" grommet and into the engine compartment (See Photo 4, below).
5. Route the blower power and ground wires (orange/white) through the 5/8" grommet and into the engine compartment (See Photo 5, below).
6. Enlarge the hole on the relay mounting tab to accommodate the #14 x 3/4" washer head screw installed on the kick panel cover (See Photo 6, below).
7. Select a suitable ground location for the white ground wire eyelet from the heater control valve harness, then secure it using a #12 x 1/2" self-tapping screw (See Photo 7, below).

Locate heater control valve plug on main wiring harness through (white/yellow/purple)

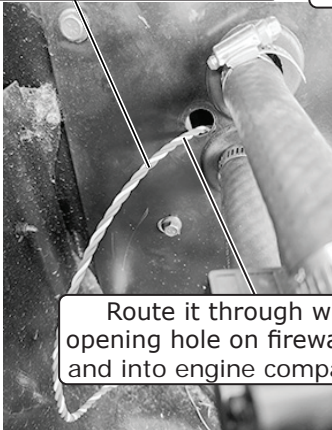

Route it through wiring opening hole on firewall cover and into engine compartment

Photo 1

Install 5/8" grommet over heater control valve plug and install on firewall cover

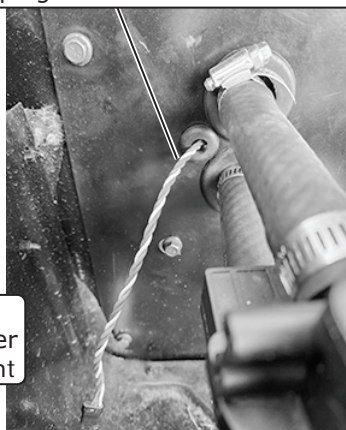

Photo 2

Plug heater control valve connector to main wiring harness



Photo 3

Route red, white and blue wires from main wiring harness through 5/8" grommet



Photo 4

Route blower power and ground wires (orange/white) through 5/8" grommet



Photo 5

Enlarge hole on relay mounting tab

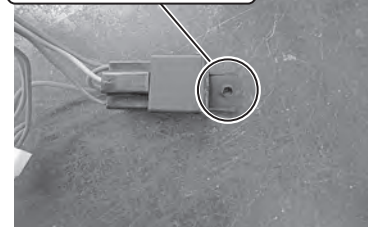

Photo 6

Attach white ground wire eyelet from heater control valve to suitable ground

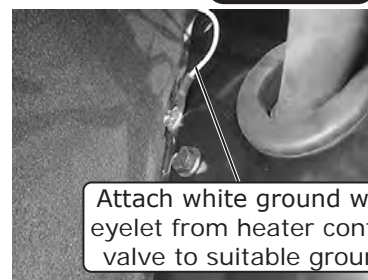

Photo 7



www.vintageair.com

Wiring Installation (Cont.)

8. Install the main wiring harness relay onto the kick panel cover with the remaining #14 x 3/4" washer head screw (See Photo 8, below). **NOTE: Main wiring harness relay in Photo 7, below, may not depict actual part included in kit.**
9. Route the violet power wire to a switched 12v power source on the fuse panel (See Photo 9, below). **NOTE: This requires a male fuse extension (not supplied).**
10. Connect the tan wire to the factory dash lights to enable control panel backlighting.
11. Connect the BSC wiring to the main harness (See Photo 10, below).
12. The ECU will be relocated for easy access and clearance of the evaporator module under the dash.
13. Install (2) pieces of Velcro on the back of the Magnum ECU (See Photo 11, below).
14. Plug the main wiring harness into the ECU (See Photo 12, below). Do not secure the ECU yet, the control panel plug must be connected first, shown in Control Panel Installation, Page 30.
15. Route the power and ground wires toward the battery.
16. Install the supplied heat shrink over the 12 AWG orange fuse holder assembly wire, and crimp it to the 12 AWG orange wire from the main wiring harness (See Photo 13, below and Quality Crimp Guidelines, Page 33).
17. Install the supplied heat shrink over the 16 AWG black fuse holder assembly wire, and crimp it to the 16 AWG red wire from the main wiring harness (See Photo 14, below and Quality Crimp Guidelines, Page 33).

Install main wiring harness relay to kick panel cover with remaining #14 x 3/4" washer head screw

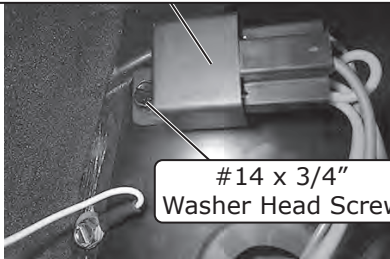

#14 x 3/4" Washer Head Screw

Photo 8

Connect BSC wiring to main harness

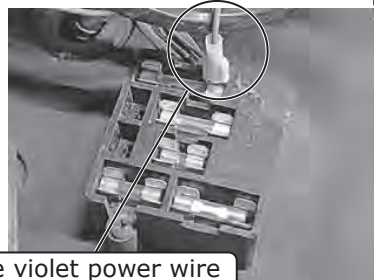

Route violet power wire to switched 12V power source on fuse panel

Photo 9



Photo 10

Install (2) pieces of Velcro on back of Magnum ECU

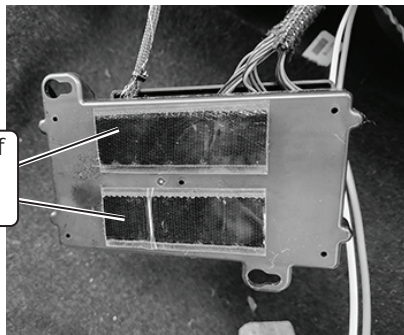

Photo 11

Plug main wiring harness into ECU



Photo 12

Install supplied heat shrink over 16 AWG black fuse holder assembly wire and crimp to 16 AWG red wire from main wiring harness

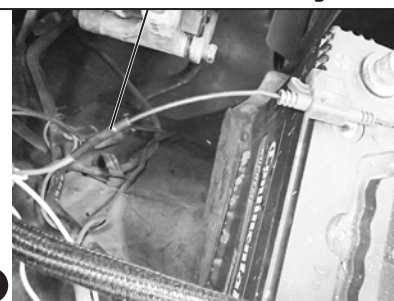

Photo 14

Install supplied heat shrink over 12 AWG orange fuse holder assembly and crimp to 12 AWG orange wire from main wiring harness

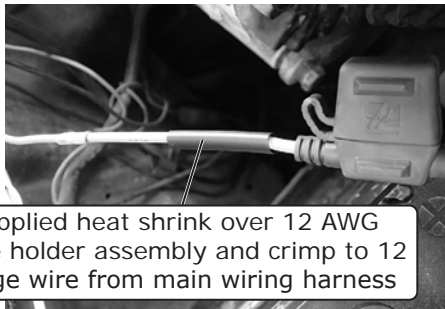

Photo 13



www.vintageair.com

Wiring Installation (Final)

18. Install fuses into the holders (See Photo 15, below).
19. Install the supplied heat shrink over the white ground wires, then crimp on the supplied eyelets (See Photos 16 and 17, below and Quality Crimp Guidelines, Page 33).
20. Connect the ground wiring eyelets to the negative battery terminal connector (See Photo 18, below).
21. Connect the positive wiring eyelets to the positive battery terminal connector (See Photo 19, below).
NOTE: Do not connect power until installation is completed.
22. Route the blue wire from the main wiring harness along the inner fender toward the drier, and secure it to the #6 A/C hose with the supplied tie wraps. Crimp the supplied 1/4" female terminal to the blue wire, and connect it to the safety switch on the drier (See Photo 20, below).
23. Connect the bullet terminal of the compressor lead to the compressor bullet terminal (See Photo 21, below).
24. Route the compressor lead wire along the #8 A/C hose. Secure the compressor lead wire to the #8 A/C hose with the supplied tie wraps. Connect the 1/4" female terminal of the compressor lead to the safety switch on the drier (See Photo 22, below).



Install fuses into holders

Photo 15

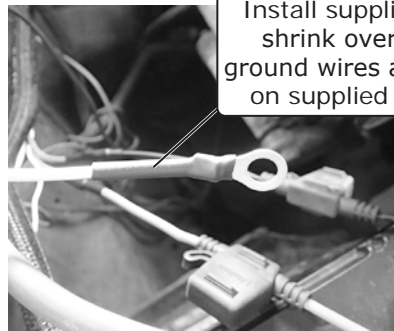

Install supplied heat shrink over white ground wires and crimp on supplied eyelets

Photo 16

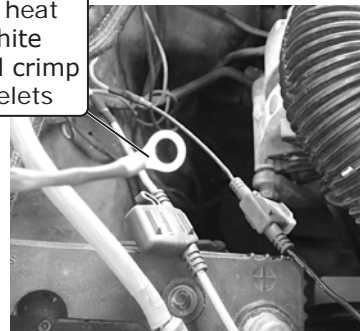
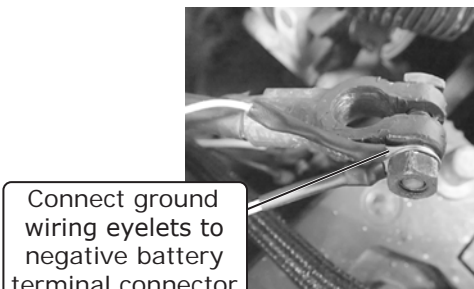
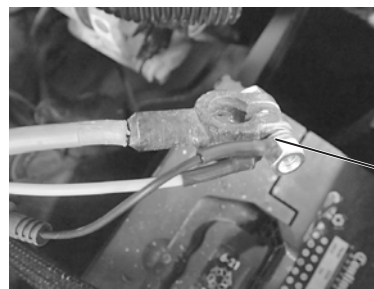

Photo 17



Connect ground wiring eyelets to negative battery terminal connector

Photo 18



NOTE: Do not connect power until installation is completed.

Connect positive wiring eyelets to positive battery terminal connector

Photo 19

Crimp supplied 1/4" female terminal to blue wire, connect it to safety switch on drier

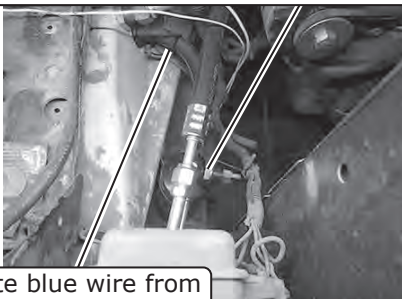
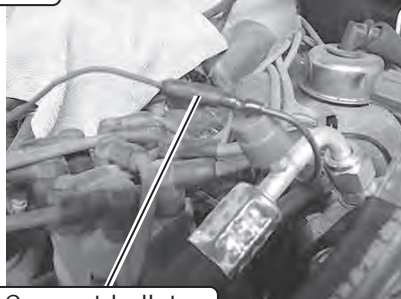

Photo 20

Route blue wire from main wiring harness along inner fender toward drier and secure it to #6 A/C hose with supplied 4" tie wraps



Connect bullet terminal of compressor lead to compressor bullet terminal

Photo 21

Secure compressor lead wire to #8 A/C hose with supplied tie wraps



Photo 22

Connect 1/4" female terminal of compressor lead to safety switch on drier



www.vintageair.com

Control Panel Installation

NOTE: Before installation, refer to the instructions included with the control panel.

1. Install the new Vintage Air control panel into the OEM control panel/radio bracket, and secure it using (4) #8 x 1/2" pan head screws (See Photo 1, below). Reinstall the bracket assembly into the dash opening using OEM hardware.
2. Plug in the OEM rear window/auxiliary tank switch connection, if equipped.
3. Route the Vintage Air control panel wiring to the ECU and connect the plug (See Photo 2, below).
4. Vintage Air recommends placing the ECU under the dash in front of the evaporator for easy access (See Photo 3, below). Clean the surface and install the ECU.
5. Reinstall the radio and plug in connections.

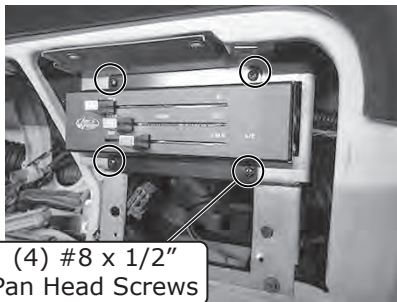

Photo 1



Photo 2

Place ECU under
dash in front of
evaporator for
easy access





www.vintageair.com

Final Steps: Installation Check

Installation Check	
ITEM TO CHECK	Procedure
<input type="checkbox"/>	<p>ECU</p> <p>If no blinking is observed after 1 minute of turning the ignition on, go to the next check.</p> <p>If repetitive blinking is observed, go to the Advanced Diagnostics Section to diagnose.</p>
<input type="checkbox"/>	<p>Blower speed control</p> <p>Set the blower speed control to OFF, <u>confirm that the blower is off</u>.</p> <p>Position the blower speed control to LOW then MEDIUM and then HIGH. <u>At each setting confirm that the blower speed increases</u>, do this by feeling for the amount of air coming from the unit and hearing the blower speed increase.</p>
<input type="checkbox"/>	<p>Mode control</p> <p>Set the MODE control to the DASH position. <u>Confirm that air is being blown at the dash vents</u>.</p> <p>Set the MODE control to the FLOOR position. <u>Confirm that air is being blown at the floor vents</u>.</p> <p>Set the MODE control to the DEFROST position. <u>Confirm that all air is being blown from the defrost vents</u></p> <p>If heater lines are installed:</p> <p>Set the MODE control to the DASH position. Set the TEMP control to the MAX HEAT position. <u>Confirm that HOT air is coming from the dash vents</u>.</p>
<input type="checkbox"/>	<p>Temperature control</p> <p>If system is charged:</p> <p>Set the TEMP control to the MAX COOL position. <u>Confirm that COLD air is coming from the dash vents</u>.</p> <p>Also <u>confirm that the compressor "clicks" on</u> when adjusting the TEMP control from the MAX HEAT position to the MAX COOL position.</p>
<input type="checkbox"/>	<p>AC Indicator (If applicable)</p> <p>While the MODE control is set to the DASH position, and the TEMP control is set to the MAX COOL/MIN HEAT position, <u>confirm that the blue AC Indicator light is on</u>.</p>
<input type="checkbox"/>	<p>Backlight (If applicable)</p> <p>If your control panel has backlight capabilities and has been wired, turn the dash lamp on and <u>confirm that the AC panel's legend is lit</u>.</p>
<input type="checkbox"/>	<p>Fittings</p> <p>Verify AC and Heater fittings are all tight.</p>



www.vintageair.com

Glove Box Installation

1. Insert the glove box into the dash opening (left side first, clearing the glove box door tab, then rotate into place) (See Photo 1, below). Pull the glove box into the correct position against the back of the dash opening, then mark the (4) mounting holes and the (4) glove box door mounting holes (See Photo 2, below).
2. Remove the glove box and drill out marks using a 3/16" drillbit. Install (4) #8 U-nuts onto the glove box mounting holes as shown in photo Photo 3, below.
3. Reinstall the glove box into the dash opening and secure it using (4) #8 x 1/2" pan head screws (See Photo 4, below).
4. Reinstall the glove box door using the OEM hardware (See Photo 5, below).



Photo 1

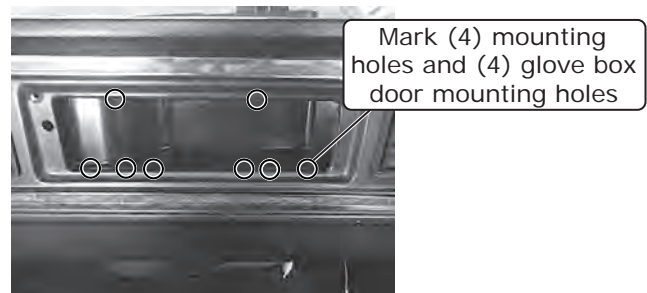

Photo 2

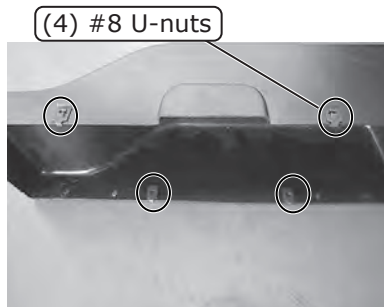

Photo 3

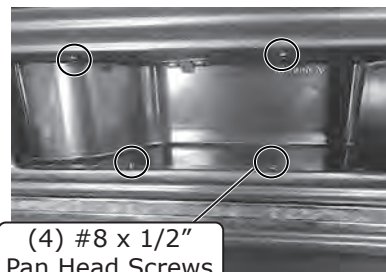

Photo 4

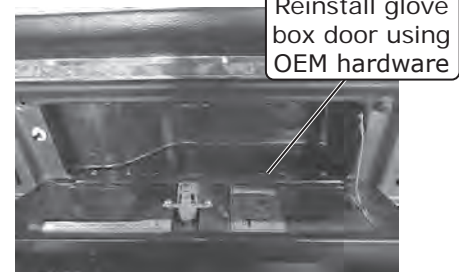

Photo 5

Final Steps: Completing the Install

1. Connect the speedometer cable and connection plug to the gauge cluster and reinstall it into the dash using the OEM hardware.
2. Reinstall the gauge bezel connecting the driver side duct hose to the louver.
3. Reinstall any other previously removed items.
4. Fill radiator with at least a 50/50 mixture of approved antifreeze and distilled water. It is the owner's responsibility to keep the freeze protection at the proper level for the climate in which the vehicle is operated. Failure to follow antifreeze recommendations will cause heater core to corrode prematurely and possibly burst in A/C mode and/or freezing weather, voiding your warranty.
5. Double check all fittings, brackets and belts for tightness.
6. Vintage Air recommends that all A/C systems be serviced by a licensed automotive technician.
7. Evacuate the system for a minimum of 45 minutes prior to charging, and perform a leak check prior to servicing.
8. Charge the system to the capacities stated on Page 4 of this manual.
9. See the Operation of Controls procedures on Page 34 of this manual.



www.vintageair.com

Quality Crimp Guideline

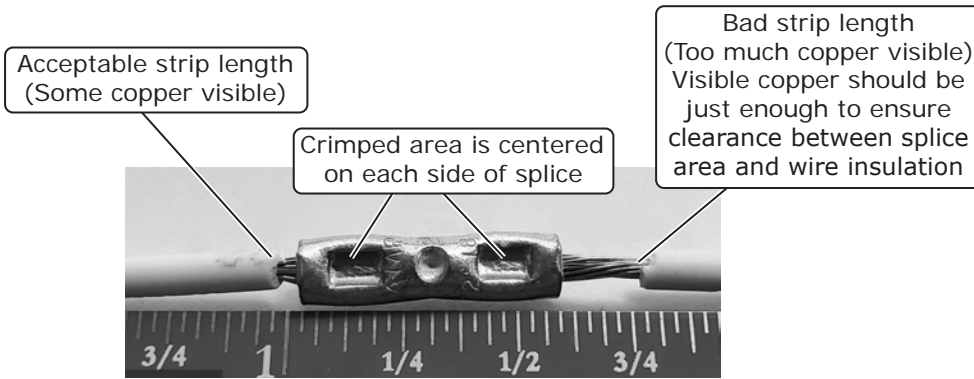

Photo 1

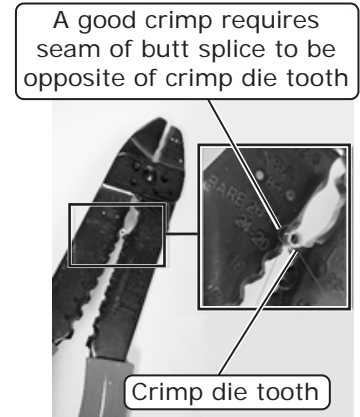

Photo 2

Good Ring Terminal Crimp Bad Ring Terminal Crimp



Photo 3

Crimp area is centered on barrel

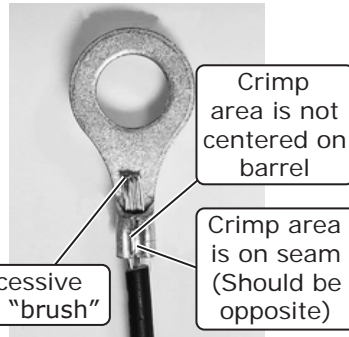

Photo 4



Photo 5

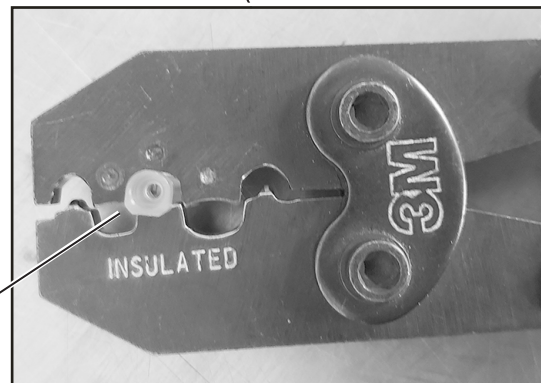

Photo 5a

Use a ratcheting crimp tool for insulated barrel terminals when crimping the provided female insulated terminal. Ensure terminal is inserted in appropriate position before crimping.



www.vintageair.com

Gen 5 Wiring Diagram

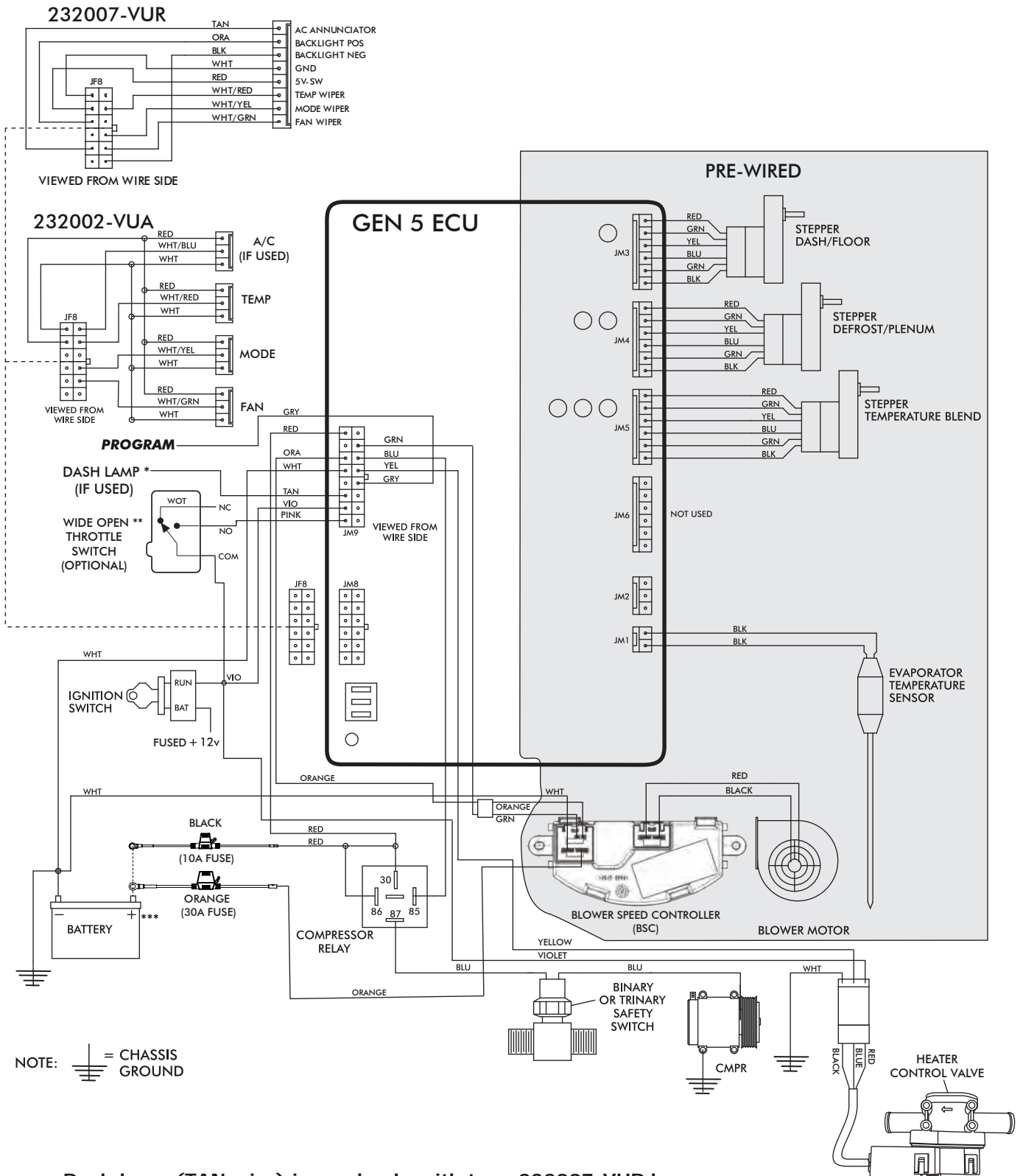

NOTE: = CHASSIS GROUND

- * Dash lamp (TAN wire) is used only with type 232007-VUR harness.
- ** Wide open throttle switch contacts close only at full throttle, which disables A/C compressor.
- *** Install fuse assemblies at or as near to the battery as possible.



www.vintageair.com

Gen 5 Wiring Instructions

WIRING HARNESS (231505) ↓

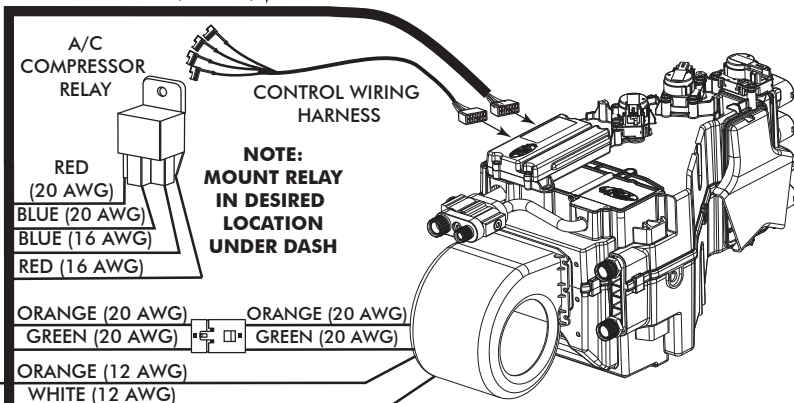

NOTE:
MOUNT RELAY
IN DESIRED
LOCATION
UNDER DASH

Ignition Switch:
Using provided butt splice (PN 226004), connect the 20 AWG violet wire to a 5A fused and switched 12V source such as Key On.

Wide Open Throttle Switch (Optional):
If a wide open throttle switch is required, connect the 20 AWG pink wire to a normally open switch that, when closed, connects a fused and switched 12V source to the pink wire. See Gen 5 wiring diagram for an example.

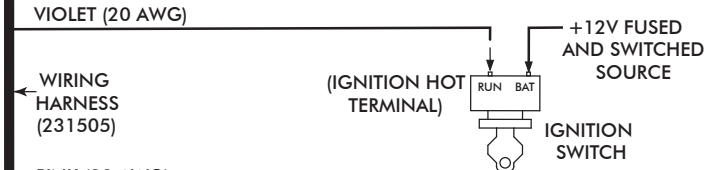

Dash Light (Optional):
If using a Vintage Air control panel with back light, connect the 20 AWG tan wire to the vehicle's dash back light 0-12V using provided butt splice (PN 226004).

WIRING HARNESS (232020) →

FIREWALL FIREWALL

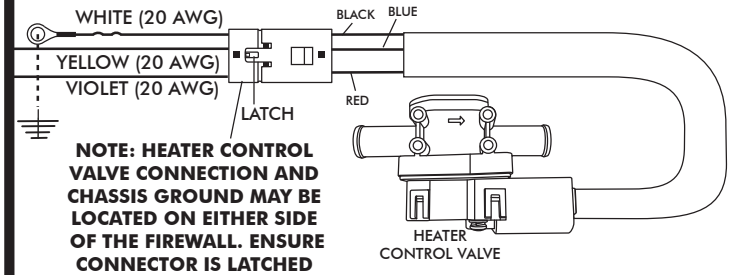

NOTE: HEATER CONTROL VALVE CONNECTION AND CHASSIS GROUND MAY BE LOCATED ON EITHER SIDE OF THE FIREWALL. ENSURE CONNECTOR IS LATCHED FIRMLY.

Heater Control Valve:
Connect the Violet/Yellow/White twisted branch with 3 position connector into the heater control valve connector. Ensure that the mating latch is fully seated.

Binary/Trinary & Compressor:
Binary Switch: Terminate provided insulated female terminal (PN 23172-VUW) to the blue 16 AWG wire. Connect as shown.
Trinary Switch: Connect according to trinary switch wiring diagram.

WIRING HARNESS (232020) →

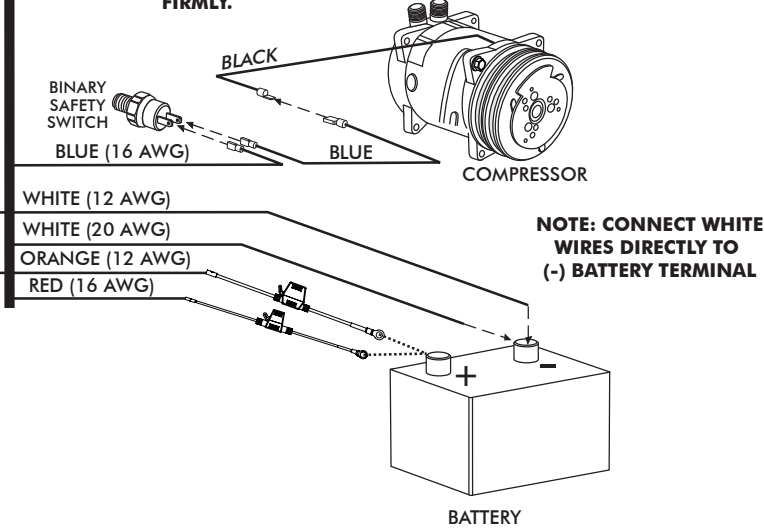

NOTE: CONNECT WHITE WIRES DIRECTLY TO (-) BATTERY TERMINAL

Battery Connections:
ECU Ground: Terminate provided ring terminal (PN 226110) to 20 AWG white wire from the 231505 wire assembly and install at battery.
ECU PWR: Terminate provided fuse assembly with black leads (PN 233012) to the 16 AWG red wire from the 231505 wire assembly. Install provided 10A Red Mini Fuse (PN 226118). Install at battery.
Blower Speed Controller (BSC) Ground: Terminate provided ring terminal (PN 226111) to 12 AWG white wire from the 232020 wire assembly and install at battery.
Blower Speed Controller (BSC) PWR: Terminate provided fuse assembly with orange leads (PN 233008) to the 12 AWG orange wire from the 232020 wire assembly. Install provided 30A Green ATO/ATC Fuse (PN 226125). Install at battery.



www.vintageair.com

Operation of Controls

On Gen IV and Gen 5 systems with three lever/knob controls, the temperature control toggles between heat and A/C operations. To activate A/C, move the temperature lever/knob all the way to cold and then back it off to the desired vent temperature. For heat operation, move the temperature lever/knob all the way to hot and then adjust to the desired vent temperature. The blower will momentarily change speed, each time you toggle in and out of heat and A/C operations, to indicate the change.

Blower Speed

This lever/knob controls blower speed, from OFF to HI.

Mode Control

This lever/knob controls the mode positions, from DASH to FLOOR to DEFROST, with a blend in between.

Temperature Control

This lever/knob controls the temperature, from HOT to COLD.

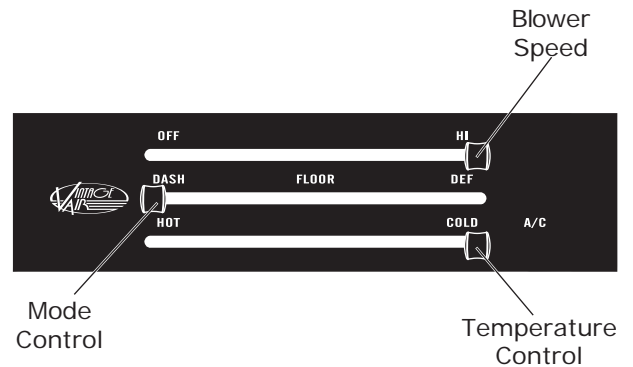

A/C Operation

Blower Speed

Adjust to desired speed.

Mode Control

Adjust to desired mode position (DASH position recommended).

Temperature Control

For A/C operation, adjust to coldest position to engage compressor (adjust between HOT and COLD to reach desired temperature).



Heat Operation

Blower Speed

Adjust to desired speed.

Mode Control

Adjust to desired mode position (FLOOR position recommended).

Temperature Control

For maximum heating, adjust to hottest position (adjust between HOT and COLD to reach desired temperature).



Defrost/De-fog Operation

Blower Speed

Adjust to desired speed.

Mode Control

Adjust to DEFROST position for maximum defrost, or between FLOOR and DEFROST positions for a bi-level blend (Compressor is automatically engaged).

Temperature Control

Adjust to desired temperature.





www.vintageair.com

Troubleshooting Guide

This printed troubleshooting guide is our basic guide that covers common installation problems. To see our advanced diagnostics and troubleshooting guide, please refer to the following page for instructions on how to download the complete guide.

WARNING: While troubleshooting the system, never probe connector terminals from the front mating side, only back probe.

WARNING: While troubleshooting the system, never use automotive check lights.

Symptom	Condition	Checks	Actions	Notes
1. Blower stays on high speed with ignition on.	No other functions work.	Check for damaged pins or wires in the control panel wire assembly and mating header at ECU.	If found damaged, replace wire assembly or ECU.	If fuse continues to blow, there is a serious problem in the wiring. Check all wiring and ensure the wire is not damaged and shorting out along its route.
	All other functions work.	Check for a bad ECU GND. Check for damaged pins or wires in the control panel wire assembly and mating header at ECU. Check if Blower power fuse is blown. Check for a bad ECU GND.	If found damaged, replace wire assembly or ECU. Replace fuse. Repair connection.	
2. Compressor will not turn on (All other functions work).	System is not charged.	System must be charged for compressor to engage.	Charge system.	Danger: Never bypass safety switch with engine running. Serious injury can result.
	System is charged.	Check for faulty A/C potentiometer or associated wiring (not applicable to 3-pot controls).	Check continuity to ground on white control head wire. Check for 5V on red control head wire.	To check for proper pot function, check voltage at white/red wire. Voltage should be between 0V and 5V, and will vary with pot lever position.
		Check for disconnected or faulty thermistor.	Check 2-pin connector at ECU housing.	Disconnected or faulty thermistor will cause compressor to be disabled.
3. Compressor will not turn off (All other functions work).	Compressor will not turn off (All other functions work).	Check for faulty A/C potentiometer or associated wiring.	Repair or replace pot/control wiring.	Red wire at A/C pot should have approximately 5V with ignition on. White wire will have continuity to chassis ground. White/Red wire should vary between 0V and 5V when lever is moved up or down.
		Check for faulty A/C relay.	Replace relay.	



www.vintageair.com

Troubleshooting Guide (Cont.)

Symptom	Condition	Checks	Actions	Notes
4. System will not turn on, or runs intermittently.	Works when engine is not running; shuts off when engine is started	Noise interference from either ignition or alternator.	Install capacitors on ignition coil and alternator. Ensure good ground at all points. Relocate coil and associated wiring away from ECU and ECU wiring. Check for burned or loose plug wires.	Ignition noise (radiated or conducted) will cause the system to shut down due to high voltage spikes. If this is suspected, check with a quality oscilloscope. Spikes greater than 16V will shut down the ECU. Install a radio capacitor at the positive post of the ignition coil (see radio capacitor installation bulletin). A faulty alternator or worn out battery can also result in this condition.
	Will not turn on under any conditions.	Verify connections on power lead, ignition lead, and both white ground wires.	Check for power at ECU, and confirm ignition is being applied to ECU properly.	
		Verify battery voltage is greater than 10 volts and less than 16 while engine is running.	Verify proper meter function by checking the condition of a known good battery.	
		Check for damaged mode switch or potentiometer and associated wiring.		
5. Loss of mode door function.	No mode change at all.	Check for at least 12V at circuit breaker.	Ensure all system grounds and power connections are clean and tight.	System shuts off blower at 10V. Poor connections or weak battery can cause shutdown at up to 11V.
		Battery voltage is less than 12V.	Charge battery.	
6. Blower turns on and off rapidly.		Check for faulty battery or alternator.		
		Check for damaged switch or pot and associated wiring.	Repair or replace.	
7. Erratic functions of blower, mode, temp, etc.				

Advanced Diagnostics and Troubleshooting Guide

If after referencing the Troubleshooting Guide, the issue is not resolved, move to The Advanced Diagnostics and Troubleshooting Guide that covers the following:

- ECU Diagnostics Codes
- 1. ECU Blink Sequence
- 2. Firmware Version Number
- 3. ECU Model Number
- 4. ECU Start-Up Blink Sequence
- 5. Diagnostic Codes
- Complete Advanced Troubleshooting Guidelines

Access the latest version of the Advanced Diagnostics and Troubleshooting Guide by scanning the following QR code on your mobile device:



You can also access the guide by typing the following address into your web browser:

https://www.vintageair.com/instructions_pdf/905000.pdf



www.vintageair.com

Packing List: Evaporator Kit (751685)

No.	Qty.	Part No.	Description
1.	1	765200	Gen 5 Magnum Max Module with 404 ECU
2.	1	791685	Accessory Kit

Checked By: _____
Packed By: _____
Date: _____

1



Gen 5 Magnum Max
Module with 404 ECU
765200

2

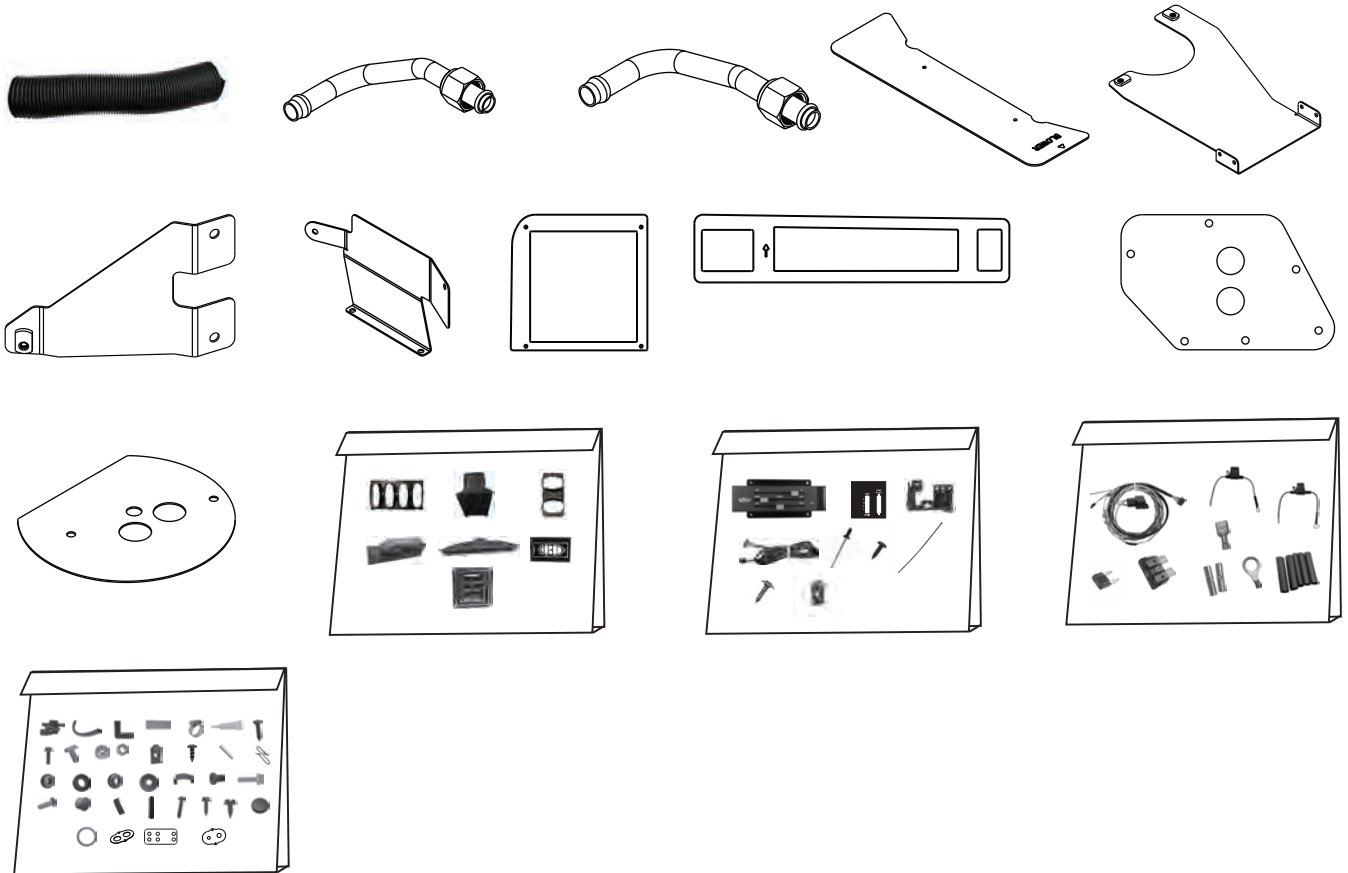

Accessory Kit
791685

**NOTE: Images may not depict actual parts and quantities.
Refer to packing list for actual parts and quantities.**