



**FORD PERFORMANCE**

# M-6017-73M 7.3L Engine Control Pack Installation Instructions

NO PART OF THIS DOCUMENT MAY BE REPRODUCED WITHOUT PRIOR AGREEMENT AND WRITTEN PERMISSION OF  
FORD PERFORMANCE PARTS © Ford Motor Company 2020

**For questions, Call the FORD PERFORMANCE Techline 1-800-367-3788**

Please visit <https://www.performanceparts.ford.com> for warranty information



## TABLE OF CONTENTS

Section	Topic	Page
1.0	Introduction	2
2.0	Overview	2
3.0	Included Components	2
4.0	Pre-Installation of Harness and Parts	6
5.0	Controls Pack Harness Installation Instructions	7
6.0	Ford Performance Power Distribution Box Installation	12
7.0	Fuel System	14
8.0	Wire Usage Schematics	15
9.0	Fuses & Relays	18
10.0	Troubleshooting Tips	19
11.0	Connector Faces	19
12.0	CAN Message Definition	28
13.0	Wiring Schematics (control pack, starter system, PCM pinout)	29

Ford Factory Shop Manual purchase options [www.motorcraftservice.com](http://www.motorcraftservice.com)



FORD PERFORMANCE

M-6017-73M

## 7.3L Engine Control Pack Installation Instructions

NO PART OF THIS DOCUMENT MAY BE REPRODUCED WITHOUT PRIOR AGREEMENT AND WRITTEN PERMISSION OF FORD PERFORMANCE PARTS © Ford Motor Company 2020

### 1.0 - Introduction

This kit was developed by Ford Performance in order to allow performance enthusiasts the ability to install and run a 7.3L Crate Engine (Ford Performance P/N: M-6007-73) into any Vehicle. The manual transmission kit is designed to work with Tremec T-56 (M-7003-M6266) or manual transmission with similar specifications.

Note: Cruise control is not available with this system. GPS or drive shaft speed sensors signals are suggested for vehicle speed.

### 2.0 - Overview

This booklet provides a step by step guide for the preparation and assembly of the control pack. Please read the instructions thoroughly before starting the installation. If you have any questions, contact the Ford Performance Techline at (800) 367-3788.

### 3.0 - Included Components

Below is a Bill of Materials included in this kit followed by detailed notes

Part #	Description
CM-12A650-AANPM	7.3L MANUAL PCM WITH CALIBRATION
CM-14A006-AM73	7.3L AUTO/MANUAL CONTROL PACK MAIN HARNESS
CM-14A006-M73T	7.3L MANUAL TRANS HARNESS
CM-9474-M5087	ADAPTER GT350 TB TO GT INTAKE
FR3Z-9600-J	AIR CLEANER ASSEMBLY
FR3Z-12A647-B	AMBIENT AIR TEMPERATURE SENSOR
GR3Z-9E936-A	GASKET - THROTTLE BODY
HC3Z-9F836-A	ACCELERATOR PEDAL
JX6Z-12B579-A	MAF SENSOR
KR3Z-6758-A	CRANKCASE VENTILATION TUBE
KR3Z-9E926-A	THROTTLE BODY
LC3Z-9F472-F	UEGO UPSTREAM O2 SENSOR
PC-3001	PACKAGING CARTON
W500103-S437	BOLT THROTTLE BODY
6G9Z-11A152-A	CLUTCH POSITION SWITCH

Ford Factory Shop Manual purchase options [www.motorcraftservice.com](http://www.motorcraftservice.com)



FORD PERFORMANCE

M-6017-73M

## 7.3L Engine Control Pack Installation Instructions

NO PART OF THIS DOCUMENT MAY BE REPRODUCED WITHOUT PRIOR AGREEMENT AND WRITTEN PERMISSION OF FORD PERFORMANCE PARTS © Ford Motor Company 2020

### 3.1 Powertrain Control Module (PCM)

- The PCM is the central processing unit for engine operation. Input data/engine operation feedback is provided from each of the engine's sensors connected to the PCM via wiring leads. This input data is used to perform calculations that in turn adjust fuel/air quantity and spark timing according to varying driver demand (ie – accelerator pedal input).
- The PCM in this Controls Pack has a custom software and calibration dataset which were specifically developed by Ford Performance engineers to provide peak performance and reliability with the 7.3L Crate Engine (Ford Performance P/N: M-6007-73).
- The PCM supports CAN messages for engine speed, fuel pressure, coolant temperature, oil temperature, oil pressure, battery voltage, manifold vacuum, and gear. (see section 12 for details)

#### PCM Calibration Application Notes:

- The calibration provided in this PCM works with a mechanically regulated return style fuel system. See Section 7 of this manual for more information on fuel system requirements for this PCM.
- The air filter assembly with integral mass air flow sensor included with this kit must be used to achieve acceptable engine performance. Refer to Section 3.9 for more information about air inlet system requirements.

**NOTE: Due to the fuel system requirement described above, installation of this PCM in ANY production vehicle will result in a no-start condition!**

### 3.2 Control Pack Wiring Harness

- The control pack wiring harness has pre-determined lengths that will dictate the location of certain supporting components as well as the locations of fixed components on the drive train.

### 3.3 Accelerator Pedal Position Sensor (APPS)

- The accelerator pedal assembly includes a pair of integrated pedal position sensors (APPS1/APPS2). This pedal has electrical properties designed specifically for correct interface with PCM and is required for proper engine operation.

### 3.4 Fuel Supply System (Not All Components are Included)

- See section "7.0 Fuel System" of this manual for fuel pump and regulator requirements.

### 3.5 O2 Sensors

- One O2 sensor per cylinder bank (1 upstream) provide wide range feedback to the PCM for closed loop air fuel ratio control by measuring the quantity of oxygen present in exhaust leaving the combustion chamber.
- Tighten to 48 Nm (35 lb-ft).

**NOTE: Do not splice, lengthen or otherwise modify the sensor wiring. Doing so will adversely affect the sensor performance and reliability of the signal. You may lengthen the connector leads from the harness side if necessary, by splicing, soldering and shrink wrapping the splices. The engine harness and controls package is designed to operate with the O2 sensors in the model year 2020 F-250 stock locations.**

Ford Factory Shop Manual purchase options [www.motorcraftservice.com](http://www.motorcraftservice.com)



FORD PERFORMANCE

# M-6017-73M 7.3L Engine Control Pack Installation Instructions

NO PART OF THIS DOCUMENT MAY BE REPRODUCED WITHOUT PRIOR AGREEMENT AND WRITTEN PERMISSION OF FORD PERFORMANCE PARTS © Ford Motor Company 2020

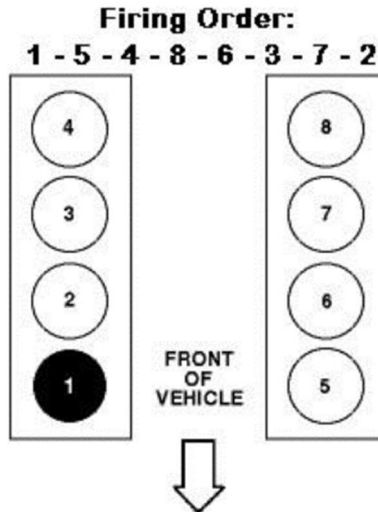

### 3.8 Plastic Bag of Assorted Items

- Inline fuse.
- Fuse holder.
- 6-way IP pigtail.
- Misc. hardware.



Ford Factory Shop Manual purchase options [www.motorcraftservice.com](http://www.motorcraftservice.com)



NO PART OF THIS DOCUMENT MAY BE REPRODUCED WITHOUT PRIOR AGREEMENT AND WRITTEN PERMISSION OF FORD PERFORMANCE PARTS © Ford Motor Company 2020

### 3.9 Air Cleaner Assembly with Integral Mass Air Flow Sensor



- A performance induction is included in the kit.
  - Throttle body and adapter plate.  
**NOTE: The passenger side ETB (electronic throttle body) locating pin needs to be removed from the intake manifold before adapter plate can be installed. To assure no debris contaminates the intake manifold, gaffer tape should be used to seal off the intake manifold at the throttle body flange. Using a die grinder or a pair of side cutters, the passenger side plastic locating pin needs to be cut off flush. A file can be used to make a flush surface if the cut is not flat.**
  - Induction tube with integrated MAF sensor.
  - Air filter.
  - Air Filter enclosure.
- You must replace the original throttle body that is installed on the engine (as shipped), with the unit included in the kit for proper operation.
- The installation of the air filter enclosure is optional and may be modified.



NO PART OF THIS DOCUMENT MAY BE REPRODUCED WITHOUT PRIOR AGREEMENT AND WRITTEN PERMISSION OF FORD PERFORMANCE PARTS © Ford Motor Company 2020

### 3.10 Ambient Air Temperature (AAT)



- The AAT must be installed in the vehicle forward of the radiator or other heat exchangers.
- The installation location must be in the flow of fresh air to provide optimum performance as it effects the calculation of the delivered spark and fuel.

### 3.11 Control Pack Wiring Assembly

- Connects to vehicle battery and inline connector on engine harness.
- Contains Ford Performance Power Distribution Box (FPPDB) and high power inline fuse.
- Electrical connections to Accelerator Pedal (APPS).
- Wire leads for Ignition Switch & Starter.
- Data Link Connector for reading Diagnostic Trouble Codes (DTCs).
- Check Engine/Malfunction Indicator Lamp (MIL) for visual indication of engine control system fault code presence.
- Only the MIL included in this kit will illuminate if a fault exists.

**NOTE: MIL will stay illuminated when the ignition is ON and the engine is NOT running; therefore this condition does not indicate a system fault. Not all DTCs will cause the MIL to illuminate.**

## 4.0 - Pre-Installation of Harnesses and Parts

The following is a list of key factors to consider before any of the installation takes place:

- PCM mounting location is limited by the length of the PCM lead of the engine harness (located on the right front corner of the engine). The PCM connector lead measures 22 inches from the lower edge of the right valve cover. This will dictate the location of where the PCM will need to be mounted.
- Ford Performance Power Distribution Box must be mounted, in the engine compartment, within 60 inches of the vehicle battery or positive battery post.
- Lay out the harness and components in order to ensure that the wiring leads will reach everywhere you intend within the vehicle. This is a necessary check before you drill any holes or mount any components!

Ford Factory Shop Manual purchase options [www.motorcraftservice.com](http://www.motorcraftservice.com)



FORD PERFORMANCE

# M-6017-73M 7.3L Engine Control Pack Installation Instructions

NO PART OF THIS DOCUMENT MAY BE REPRODUCED WITHOUT PRIOR AGREEMENT AND WRITTEN PERMISSION OF FORD PERFORMANCE PARTS © Ford Motor Company 2020

## 5.0 - Control Pack Harness Installation Instructions

Item	Connector #	Description		Item	Connector #	Description
A	-	Ford Performance Power Distribution Box		O	C132	Ambient Air Temperature Sensor
B	-	Ground		P	C400	Intercooler Pump
C	C160A	Inline to IP Pigtail		Q	C8	PATS Module
D	C2040	Accelerator Pedal Position Sensor		R	C90	PCM Connector (Trans Harness)
E	C257	Clutch Pedal Position		S	C1A	Inline to Control Pack Harness
F	C251	Data Link Connector & MIL		T	C1571	UEGO RH Bank 1 (Upstream)
G	-	HSCAN (+/-)		U	C1572	UEGO LH Bank 2 (Upstream)
H	-	Starter Solenoid		V	-	Not Included in 7.3L Harness
I	-	Cooling Fan Feed		W	-	Not Included in 7.3L Harness
J	C146	Inline to Engine Harness		-	-	-
K	C1B	Inline to Trans Harness		-	-	-
L	C175B	PCM Connector (Control Pack)		-	-	-
M	C128	Mass Air Flow Sensor		-	-	-
				-	-	-

Table 1 – Summary of Controls Pack Connectors

Ford Factory Shop Manual purchase options [www.motorcraftservice.com](http://www.motorcraftservice.com)



FORD PERFORMANCE

# M-6017-73M 7.3L Engine Control Pack Installation Instructions

NO PART OF THIS DOCUMENT MAY BE REPRODUCED WITHOUT PRIOR AGREEMENT AND WRITTEN PERMISSION OF FORD PERFORMANCE PARTS © Ford Motor Company 2020

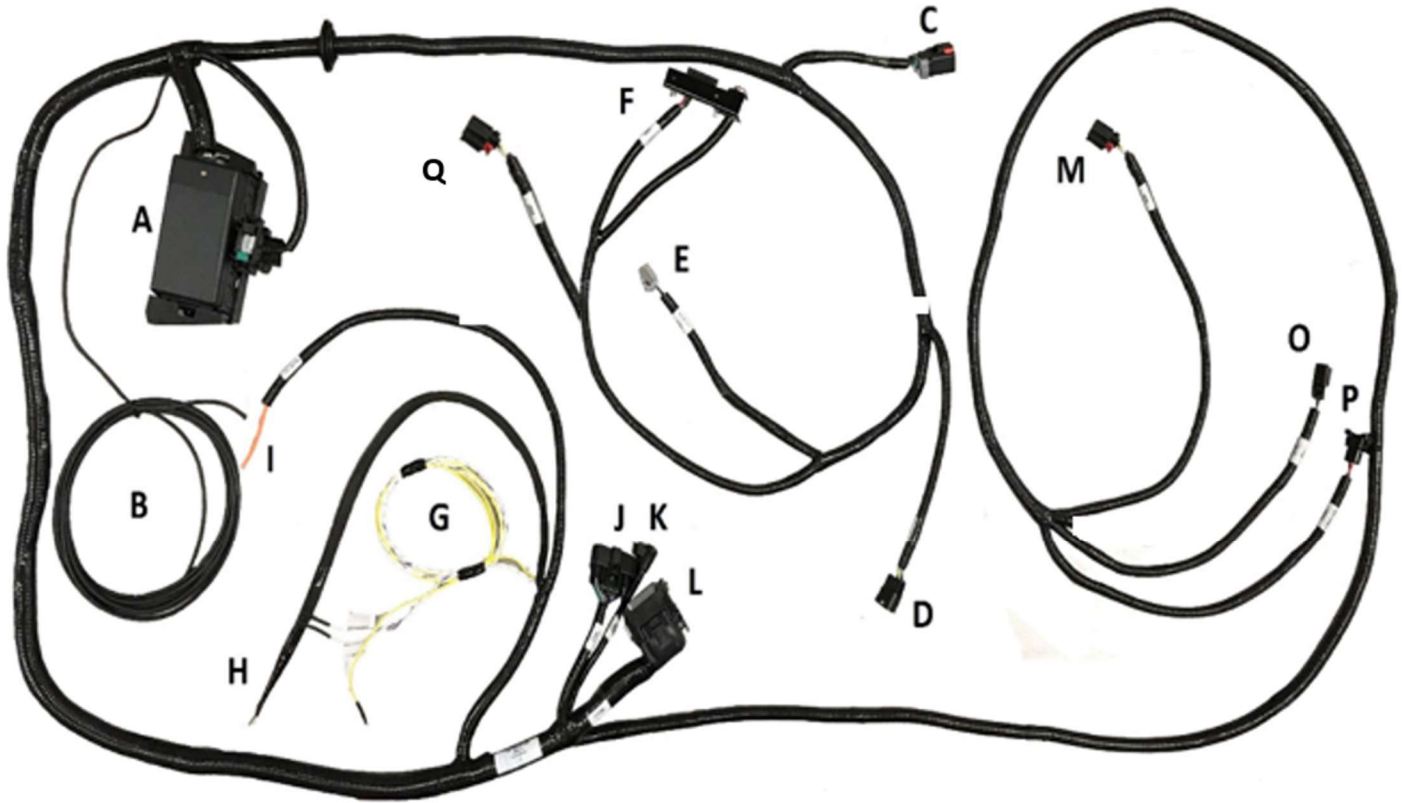

Figure 1a - 7.3L Control Pack Main Harness

Ford Factory Shop Manual purchase options [www.motorcraftservice.com](http://www.motorcraftservice.com)





NO PART OF THIS DOCUMENT MAY BE REPRODUCED WITHOUT PRIOR AGREEMENT AND WRITTEN PERMISSION OF FORD PERFORMANCE PARTS © Ford Motor Company 2020



Figure 1b – 7.3L Manual Trans Harness (Will Differ from Image Above)

### 5.1 - Control Pack Harness Installation Instructions

**NOTE:** To avoid electrical shock and/or damage to sensitive electrical control system components, before beginning any work, remove the vehicle's negative battery terminal and place a rag or towel between it and the battery negative post. **The negative battery terminal is not to be reinstalled until the last step of installation.**

1. Identify proper mounting location for the PCM, Power Distribution Box (Item A) & inline fuse holder. (Detailed Power Distribution Box and inline fuse holder information is covered in Section 6) Locate the PCM connector on the engine harness and start there.
2. Plug the PCM vehicle connector (Item L), from the controls pack harness and the PCM trans connector (Item Q) from the transmission harness into the PCM. Once plugged-in, use a zip-tie to tie the bundle of wires together.
3. Route the transmission harness so that all upstream O2 sensor connectors (Items S and T) are able to reach their corresponding sensors. Connect the O2 sensors. In the steps that follow, we will be repeating this process of using zip-ties to piggy-back/tie the harness to the existing engine harness approximately every 200 mm along the engine harness.
4. Connect connector (Item K) on Control Pack Harness to its mating connector (Item R) on the Trans Harness.
5. Connect the in-line connector (Item J) from the controls pack harness to the mating connector on the engine harness.

Ford Factory Shop Manual purchase options [www.motorcraftservice.com](http://www.motorcraftservice.com)



FORD PERFORMANCE

## M-6017-73M 7.3L Engine Control Pack Installation Instructions

NO PART OF THIS DOCUMENT MAY BE REPRODUCED WITHOUT PRIOR AGREEMENT AND WRITTEN PERMISSION OF  
FORD PERFORMANCE PARTS © Ford Motor Company 2020

6. Connect mass air flow (MAF) sensor connector (Item M) and ambient air temperature (AAT) sensor connector (Item O) to their respective locations. Be sure to avoid any pinch-points or exhaust hot-spots. NOTE: Connector (Item P) to be used for charge air coolant pump (if installed).
7. Connect blunt-cut orange 10 AWG cooling fan lead (Item I) and starter solenoid lead eyelet (Item H) to their respective locations.
8. Connect the ground eyelet (Item B) to a reliable ground point on the chassis or engine block.

**NOTE: The grommet needs to be properly installed in the firewall of your vehicle to protect the Controls Pack Harness routing that passes through to the passenger compartment. All connections previously mentioned are located under hood. All connections mentioned from this point forward are located in the passenger compartment.**

9. Identify proper mounting location for the accelerator pedal, clutch position switch and ignition switch (purchased separately).
10. Identify mounting location for the bracket with OBDII connector and Malfunction Indicator Light (Item F).
11. Route the IP pigtail (Item C) to approximately the base of the steering wheel to be connected later.
12. Connect APPS connector (Item D) and Clutch Position Switch connector (Item E) to their respective locations. NOTE: Connector C8 (Item Q) can be used for power (key on/hot at all times), ground and HSCAN (if desired for your application). See Section 11 & 12 for more information.
13. Locate the 6-way I/P Pigtail connector with blunt leads (to mate with Item C) and continue to Section 5.2.

**NOTE: \*Connector Removal Procedure\*** If there are connectors that will not be used in your application you can cut the routing leading-up to the unused connector and individually heat shrink wrap each wire. To ensure that the wires are completely isolated from one another, and the outside environment, wrap the heat-shrunked wire bundle in electrical tape to provide an additional layer of protection from moisture and dirt.

Ford Factory Shop Manual purchase options [www.motorcraftservice.com](http://www.motorcraftservice.com)



NO PART OF THIS DOCUMENT MAY BE REPRODUCED WITHOUT PRIOR AGREEMENT AND WRITTEN PERMISSION OF FORD PERFORMANCE PARTS © Ford Motor Company 2020

### 5.2 - 6-way I/P Pigtail Connection Details

**\*This is connector C160B which plugs into C160A (Item C) previously mentioned, it is the connector with blunt leads coming from it\***



The 6-way pigtail is to be connected according to the chart below. See Section 8 for diagrams of wire connection points, based on the ignition/starter switches that you intend to use. Setup A uses separate toggle switches for ignition and starter inputs, while Setup B uses an ignition cylinder with a key.

Cavity	Lead Label	Wire Color	Description
1	Fuel Pump Relay Out	GN	Provides +12V to the fuel pump
2	-	-	-
3	Starter Motor Request (SMR)	Light Blue	Apply +12V to send a request to the PCM to energize the starter solenoid
4	-	-	-
5	Ignition Relay Trigger	Light Green	Apply +12V to energize the ignition relay/wake-up the system
6	-	-	-

Ford Factory Shop Manual purchase options [www.motorcraftservice.com](http://www.motorcraftservice.com)



FORD PERFORMANCE

## M-6017-73M 7.3L Engine Control Pack Installation Instructions

NO PART OF THIS DOCUMENT MAY BE REPRODUCED WITHOUT PRIOR AGREEMENT AND WRITTEN PERMISSION OF FORD PERFORMANCE PARTS © Ford Motor Company 2020

Locate each of the blunt leads. This is where you will need to make all of the soldered connections for the harness. Before soldering any wires, however, you must first decide which set-up you will pursue by referencing Set-up A and Set-up B on pages 15 and 16.

Connect the following REQUIRED blunt leads as follows:

**Blunt Lead 1 – Fuel Pump Relay Out (Dark Green):** Connect to fuel pump positive. Separate ground for fuel pump must be provided.

**NOTE:** The fuel pump will start running any time the key is on, then if you don't start the engine, the PCM will turn it off after a couple of seconds.

**Blunt Lead 3 – Starter Motor Request (Light Blue):**

Set-up A:

Connect to input node of starter momentary switch so that 12 volts is provided when engine starting is requested.

Set-up B:

Connect to 'Start' output node of ignition cylinder so that 12 volts is provided when engine starting is requested.

**Blunt Lead 5 – Ignition Relay Trigger (Light Green):**

Set-up A:

Connect this wire to the output side of the ignition toggle switch so that 12 volts is provided when the key is in the 'Start' (cranking) and 'Run' positions.

Set-up B:

Connect to the 'Start/Run' output node of ignition cylinder so that 12 volts is provided when engine starting is requested.

NOTE: It is imperative these circuits are reliable. The PCM will interpret intermittent voltage on this circuit as a request to shut down the engine! (Hint, if your engine shuts down after a hard launch check here first).

Once all of the blunt lead connections have been soldered onto their appropriate location, connect the 6-way I/P Pigtail connector to its mating connector (Item C).

### **\*Important Note on the Starting System\***

This kit includes connections and installation instructions for PCM controlled engine starting; however, it is **not required** that the customer utilize this option. Customers may choose to use their existing non-PCM controlled starting system if desired. If non-PCM controlled starting is used, unused blunt leads should be cut to approximately 2" length and sealed using heat shrink.

Ford Factory Shop Manual purchase options [www.motorcraftservice.com](http://www.motorcraftservice.com)



FORD PERFORMANCE

## M-6017-73M 7.3L Engine Control Pack Installation Instructions

NO PART OF THIS DOCUMENT MAY BE REPRODUCED WITHOUT PRIOR AGREEMENT AND WRITTEN PERMISSION OF  
FORD PERFORMANCE PARTS © Ford Motor Company 2020

### 6.0 - Ford Performance Power Distribution Box Installation

**NOTE: DO NOT MAKE ANY ELECTRICAL CONNECTIONS TO THE BATTERY TERMINALS UNTIL INSTRUCTED.**

1. Before you start, you will need three battery cables for battery positive and ground connections. Two will be used for battery positive and one for battery ground (negative) (purchased separately. 4 AWG recommended). One battery positive lead will be from battery to 250A fuse holder and the other from fuse holder to FPPDB. One battery positive and the battery ground cable will need a battery clamp at one end and an eyelet at the other. The second battery positive cable will need an eyelet at both end (battery clamps and eyelets are purchased separately).
2. Carefully remove the nut and washers on both terminals of the in-line fuse holder and set aside.
3. Using the battery positive cable with an eyelet at both ends, place one end onto the in-line fuse holder terminal. Place one washer and nut over the eyelet and tighten down.
4. Locate the power terminal on the FPPDB. NOTE: There is a battery positive blunt lead eyelet already attached to it. Attach the second eyelet from the battery positive cable in Step 3 to the power terminal on FPPDB. Install on the FPPDB terminal in the following order: washer, battery positive cable eyelet, blunt lead eyelet, washer, and nut.
5. Place the Buss 250A fuse onto the fuse holder terminals.
6. Using the eyelet end of the second battery positive cable, place the eyelet on the opposite in-line fuse holder terminal. Place the remaining washer and nut over the eyelet and tighten down.
7. Close the cover of the in-line fuse holder.
8. Being careful not to inadvertently complete the circuit, connect the battery clamp end of the second battery positive cable to the positive terminal of the vehicle battery.
9. Verify that you have a good (clean & dry) ground path from the battery negative post to the chassis ground. Attached the eyelet end of the battery ground cable to chassis ground. Attach the battery clamp end of the ground cable to the negative terminal of the vehicle battery. NOTE: In general, the resistance from the battery ground post through to the chassis should be less than 0.1 ohm.

**NOTE: While routing battery cables avoid any sharp edges and use zip-ties to secure the cable approximately every 200 mm.**

Ford Factory Shop Manual purchase options [www.motorcraftservice.com](http://www.motorcraftservice.com)



NO PART OF THIS DOCUMENT MAY BE REPRODUCED WITHOUT PRIOR AGREEMENT AND WRITTEN PERMISSION OF FORD PERFORMANCE PARTS © Ford Motor Company 2020

### 6.1 - Suggested Battery Cable Diagram

Connect the Battery positive to the starter and alternator.

Ground the engine to the chassis.

**NOTE:** Pay close attention to the vehicle grounds. Many times, electrical issues can be traced back to insufficient ground circuits. Ensuring your vehicle is well grounded now, will save you time and frustration later.

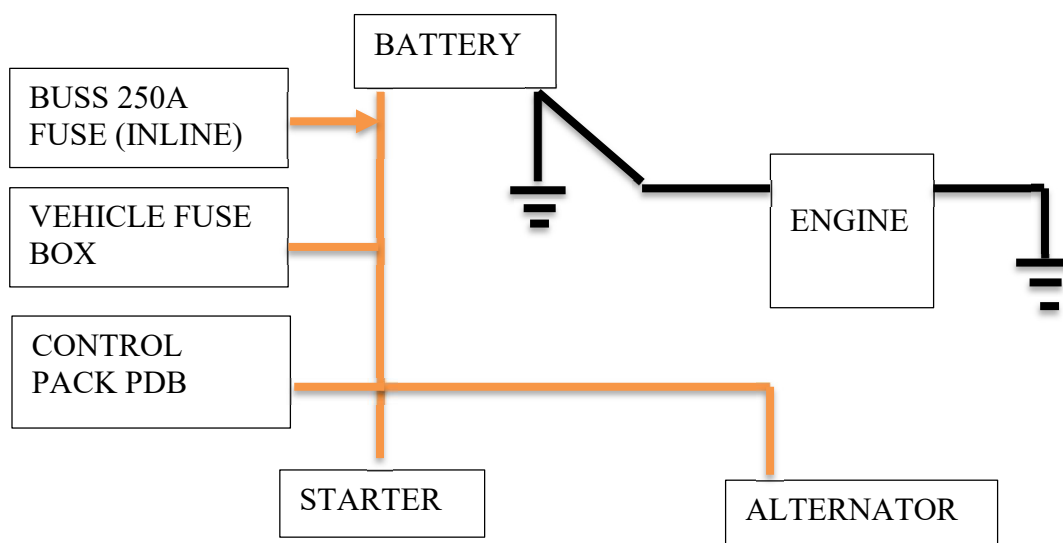

Ford Factory Shop Manual purchase options [www.motorcraftservice.com](http://www.motorcraftservice.com)



NO PART OF THIS DOCUMENT MAY BE REPRODUCED WITHOUT PRIOR AGREEMENT AND WRITTEN PERMISSION OF FORD PERFORMANCE PARTS © Ford Motor Company 2020

## 7.0 - Fuel System

The PCM is calibrated for a return style fuel system as shown below.

- Use only AN type fuel fitting to interface with OEM fuel rail.
- Fuel pump must be capable of 160 liters per hour flow at 60 psi.

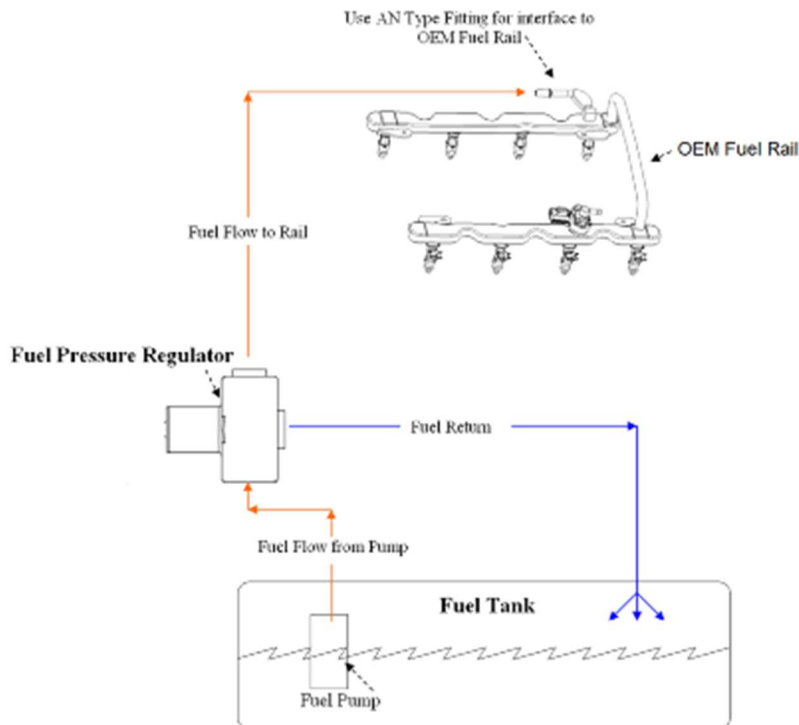

Fuel pump requirements: 160L/Hr minimum at 60 psi



FORD PERFORMANCE

M-6017-73M

## 7.3L Engine Control Pack Installation Instructions

NO PART OF THIS DOCUMENT MAY BE REPRODUCED WITHOUT PRIOR AGREEMENT AND WRITTEN PERMISSION OF FORD PERFORMANCE PARTS © Ford Motor Company 2020

### 7.1 - Fuel Pump Location

A common and often overlooked problem is the location of the fuel pump or pumps. Optimally, the fuel pump should be mounted IN THE TANK to reduce the possibility of pump cavitation. Cavitation is essentially localized boiling caused by a reduction in pressure, generally occurring on the inlet side of a pump. This localized boiling results in fuel vapor bubbles which will reduce the volume of fuel the pump is capable of delivering to the engine. Any reduction in pressure or increase in temperature at the inlet side of the pump increases the chances that cavitation will occur. For this reason, it is always best to either have the pump inside the tank immersed in fuel or (in the case of an external pump) gravity fed, which will increase the pressure on the inlet side of the pump. If the fuel pump has to “pull” the fuel, this will result in a reduction in pressure at the fuel pump inlet potentially allowing cavitation and, thus, vapor bubbles to develop. These vapor bubbles are then drawn into the fuel pump and exit the high-pressure side of the fuel pump as compressed vapor. They travel the entire length of the fuel system and are expelled through the fuel injector. This can cause issues ranging from stumbles and hesitations to engine damage due to insufficient fuel delivery and lean A/F ratios. Sometimes this problem can characterize itself by only appearing when the weather gets warmer, which can confound the diagnosis of the issue. In certain cases, it may seem to only develop when driving on certain surfaces, because pavement reflects more heat than an off-road 4x4 trail. Remember, more heat and lower pressure on the inlet side of the pump means a greater chance of cavitation, which is to be avoided whenever possible.

If you are using an external mounted fuel pump, you should run a very coarse (typically around 100 micron) filter on the inlet side of the fuel pump, and a finer (typically around 10 micron) filter on the outlet side of the pump. A paper filter is NOT recommended on the inlet of the fuel pump because it can cause a restriction in fuel flow which, as mentioned previously, can lead to cavitation.

**Warning: It is highly recommended that an inertia switch is incorporated into the fuel pump wiring to turn off the fuel pump in the event of an accident.**

### 8.0 - Wire Usage Schematics

The following two pages detail the two most common wiring configurations—please choose one to complete installation of your controls pack kit. You will need to provide a 12V Hot At All Time wire yourself.

Ford Factory Shop Manual purchase options [www.motorcraftservice.com](http://www.motorcraftservice.com)





FORD PERFORMANCE

# M-6017-73M 7.3L Engine Control Pack Installation Instructions

NO PART OF THIS DOCUMENT MAY BE REPRODUCED WITHOUT PRIOR AGREEMENT AND WRITTEN PERMISSION OF FORD PERFORMANCE PARTS © Ford Motor Company 2020

## SETUP A

### IGNITION

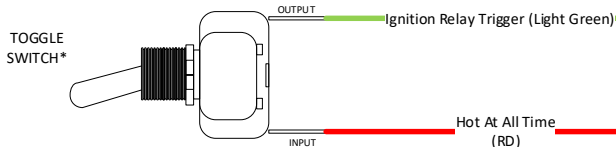

### STARTER

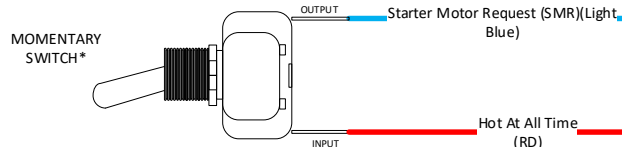

### FUEL PUMP\*

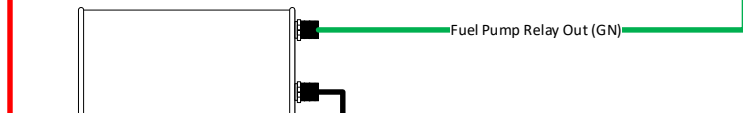

### BATTERY\*

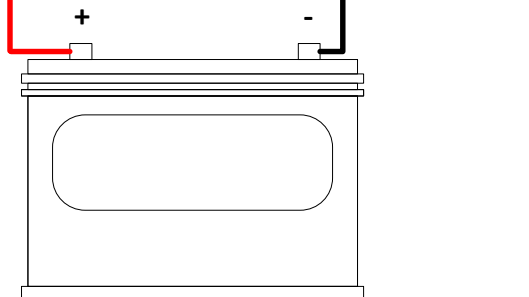

C160B

Ford Factory Shop Manual purchase options [www.motorcraftservice.com](http://www.motorcraftservice.com)



FORD PERFORMANCE

M-6017-73M

# 7.3L Engine Control Pack Installation Instructions

NO PART OF THIS DOCUMENT MAY BE REPRODUCED WITHOUT PRIOR AGREEMENT AND WRITTEN PERMISSION OF FORD PERFORMANCE PARTS © Ford Motor Company 2020

## SETUP B

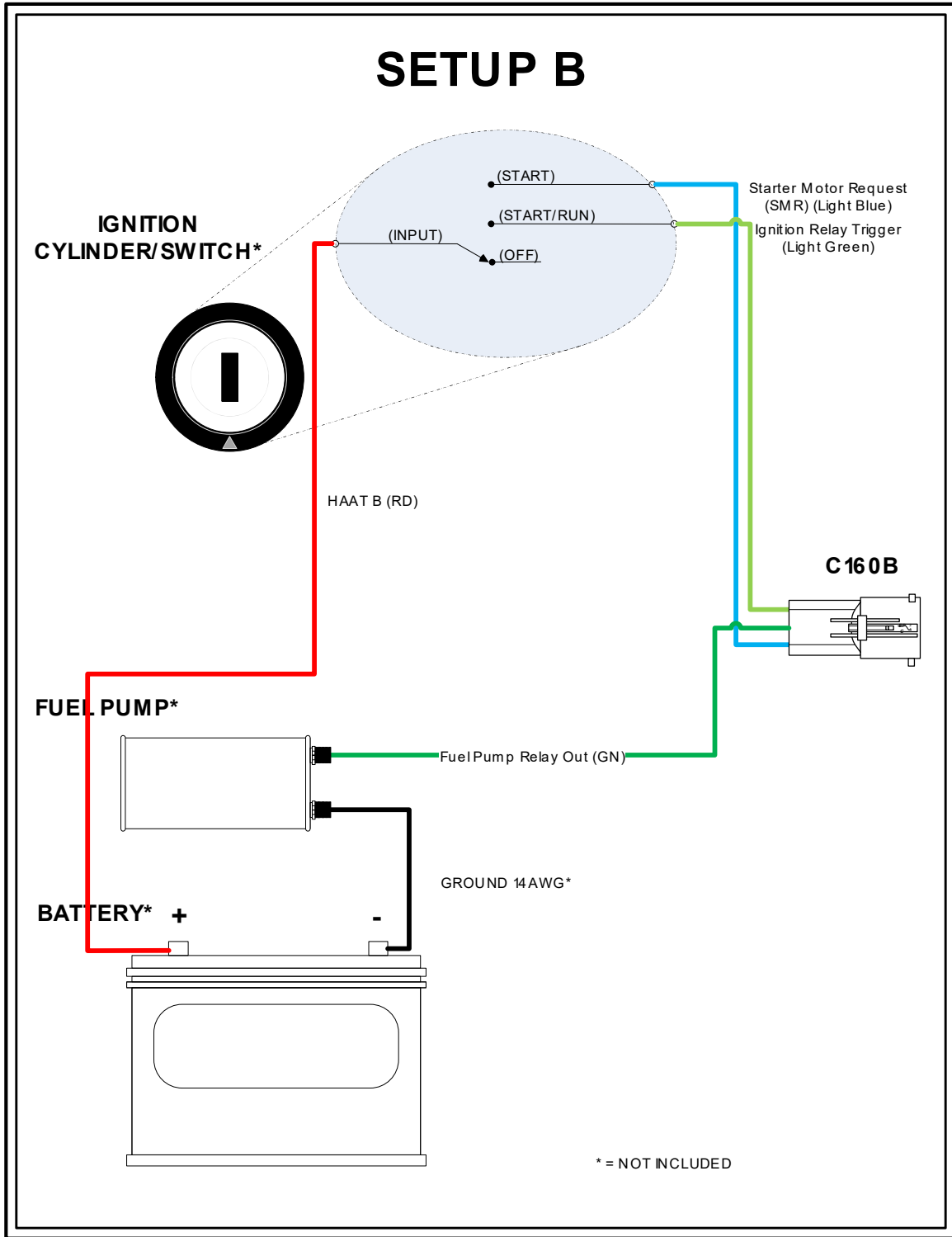

Ford Factory Shop Manual purchase options [www.motorcraftservice.com](http://www.motorcraftservice.com)



# M-6017-73M 7.3L Engine Control Pack Installation Instructions

NO PART OF THIS DOCUMENT MAY BE REPRODUCED WITHOUT PRIOR AGREEMENT AND WRITTEN PERMISSION OF FORD PERFORMANCE PARTS © Ford Motor Company 2020

## 9.0 - Fuses & Relays

- This diagram outlines the fuses and relays included in the controls pack wiring harness, and the function of each.

**WARNING:** Do NOT replace any of the fuses with a higher value than those specified below.

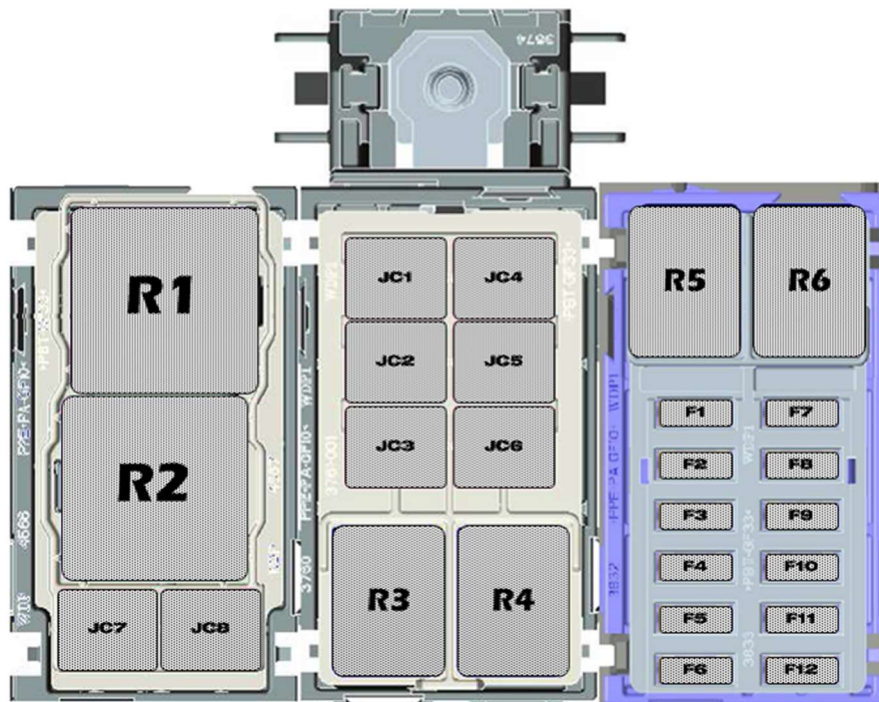

Component ID	Type	Value	Name
JC1	J-Case Fuse	50A	PCM Relay Feed
JC2	J-Case Fuse	50A	Cooling Fan Relay Feed
JC3	J-Case Fuse	30A	Starter Relay Feed
JC4	J-Case Fuse	40A	Fuel Pump Relay Feed
JC5	J-Case Fuse	40A	Ignition Relay Feed
-	-	-	-
JC7	J-Case Fuse	NOT USED	NOT USED
JC8	J-Case Fuse	NOT USED	NOT USED
F1	Minifuse	20A	VPWR1
F2	Minifuse	20A	VPWR2
F3	Minifuse	15A	VPWR3
F4	Minifuse	15A	VPWR4
F5	Minifuse	10A	Ignition Switched A
F6	Minifuse	10A	Ignition Switched B
F7	Minifuse	15A	ICP
F8	Minifuse	15A	Ignition Switched C
F9	Minifuse	15A	VPWR6
F10	Minifuse	10A	HAAT A
F11	Minifuse	10A	HAAT B
-	-	-	-
R1	Power Mini Relay	70A	PCM Relay
R2	Power Mini Relay	70A	Cooling Fan Relay
R3	High Current Micro Relay	40A	Starter Relay
R4	High Current Micro Relay	40A	Fuel Pump Relay
-	-	-	-
R6	High Current Micro Relay	40A	Ignition Relay

Ford Factory Shop Manual purchase options [www.motorcraftservice.com](http://www.motorcraftservice.com)



FORD PERFORMANCE

# M-6017-73M 7.3L Engine Control Pack Installation Instructions

NO PART OF THIS DOCUMENT MAY BE REPRODUCED WITHOUT PRIOR AGREEMENT AND WRITTEN PERMISSION OF FORD PERFORMANCE PARTS © Ford Motor Company 2020

## 10.0 - Troubleshooting tips

The following troubleshooting tips are intended to run a few quick tests to diagnose a concern or determine what the issues are before contacting the Ford Performance Techline:

- Double check all ground connections. The wiring included in this kit is extremely sensitive to ground issues. Secure all the connections (chassis grounds & vehicle battery negative post). Do a continuity test with reliable DVOM (Digital Volt Ohm Meter) between all your ground terminals and battery negative post.
- Check all reference voltages. Use a DVOM to measure the voltage at each sensor. It should read 5V.
- If none of the sensors or components have power, check the ignition switch, ignition relay R6, and PCM relay R1 wiring. It should have 12V at both relay outputs with the ignition on. This is fused via F5 and F1 separately. Use a DVOM to measure the voltage at F5 and F1, to confirm that 12V is present. Use the small holes on the mini fuses to probe and measure voltage.
- If the sensor and relay measured voltages are correct, but the engine does not crank, check the starter switch and starter relay R3 wiring. 12V should be present at the relay output when the ignition is in the crank position. Measure the voltage at the starter solenoid eyelet to confirm 12V is present during cranking.
- If your engine only cranks, but does not fire, a fuel system malfunction could be the cause. First check that 12V is present at fuel pump +, and all injectors when the key is in the on position. Measure the fuel pressure at the fuel rail, it should increase when the key is cycled to on.

## 11.0 - Connector Faces

### 11.1 – Control Pack Main Harness

C400 – Charge Air Coolant Pump (used only with supercharger)

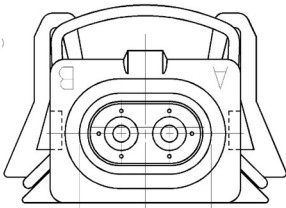

Circuit ID	AWG	Color	Function	Cavity
SGD200J	16	BK	Ground Eyelet - CHASSY	A
ICP01	16	RD	IC PUMP	B

C257 – Clutch Position Switch

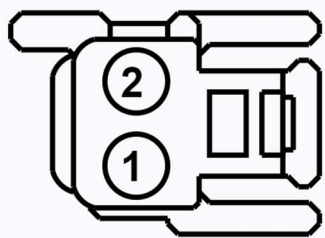

Circuit ID	AWG	Color	Function	Cavity
CET42B	20	GN-VT	Shift DOWN - CPP	1
SGD100A	20	BK	Ground Eyelet - Interior	2

Ford Factory Shop Manual purchase options [www.motorcraftservice.com](http://www.motorcraftservice.com)



FORD PERFORMANCE

# M-6017-73M 7.3L Engine Control Pack Installation Instructions

NO PART OF THIS DOCUMENT MAY BE REPRODUCED WITHOUT PRIOR AGREEMENT AND WRITTEN PERMISSION OF FORD PERFORMANCE PARTS © Ford Motor Company 2020

## C2040 – Accelerator Pedal Position Sensor (APPS)

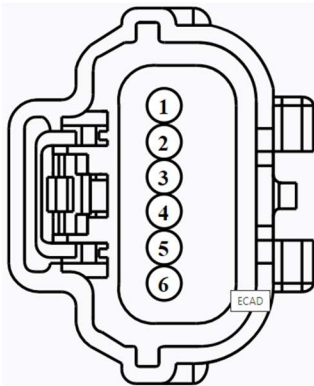

Circuit ID	AWG	Color	Function	Cavity
LE136	20	GN	APP1 VREF	1
VE701	20	YE	APP1 Signal	2
RE136	20	VT	APP1 RTN	3
RE137	20	YE	APP2 RTN	4
VE702	20	BU	APP2 Signal	5
LE137	20	BU	APP2 VREF	6

## C251 – Data Link Connector (DLC)

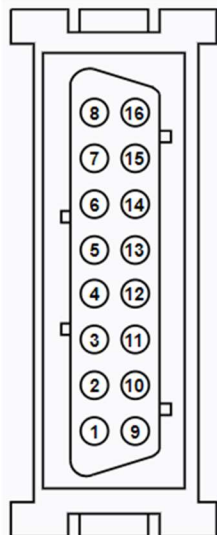

Circuit ID	AWG	Color	Function	Cavity
-	-	-	-	1
-	-	-	-	2
-	-	-	-	3
SGD100C	20	BK	Ground Eyelet - Interior	4
SGD100D	20	BK	Ground Eyelet - Interior	5
VDB04B	20	WH-BU	HSCAN (+)	6
-	-	-	-	7
-	-	-	-	8
-	-	-	-	9
-	-	-	-	10
-	-	-	-	11
-	-	-	-	12
-	-	-	-	13
VDB05B	20	WH	HSCAN (-)	14
-	-	-	-	15
DCF10	20	RD	HAAT A	16
MIL01	18	BK	Malfunction Indicator Lamp (MIL)	1
DC02B	18	RD	MIL Power B+	2

Ford Factory Shop Manual purchase options [www.motorcraftservice.com](http://www.motorcraftservice.com)



FORD PERFORMANCE

# M-6017-73M 7.3L Engine Control Pack Installation Instructions

NO PART OF THIS DOCUMENT MAY BE REPRODUCED WITHOUT PRIOR AGREEMENT AND WRITTEN PERMISSION OF FORD PERFORMANCE PARTS © Ford Motor Company 2020

## C8 – PATS Module

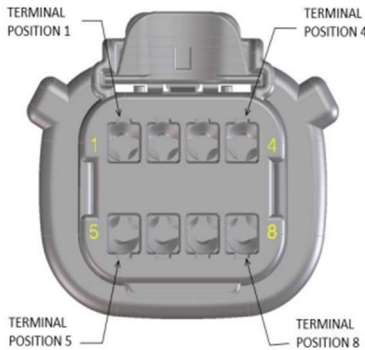

Circuit ID	AWG	Color	Function	Cavity <sup>1</sup>
-	-	-	-	1
-	-	-	-	2
VDB04D	20	WT-BU	HSCAN (+)	3
VDB05D	20	WT-BU	HSCAN (-)	4
SGD100E	20	BK	GND	5
DCF08B	20	YE	12V Key on	6
-	-	-	-	7
DCF10D	20	RD	HAAT A	8

## C128 – MAF/IAT (Mass Air Flow/Intake Air Temp)

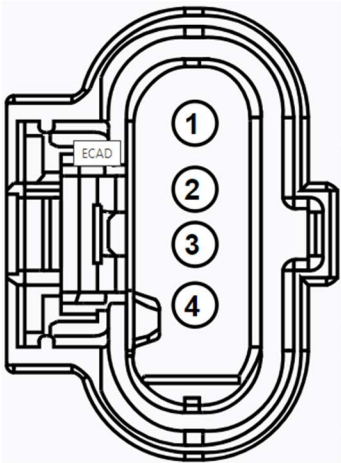

Circuit ID	AWG	Color	Function	Cavity <sup>1</sup>
VE807D	20	YE-VT	MAF	1
CE378D	20	GN-VT	VREF	2
RE320C	20	BU	MAF Return	3
VE740B	20	VT-GY	IAT	4

## C132 – AAT (Ambient Air Temp)

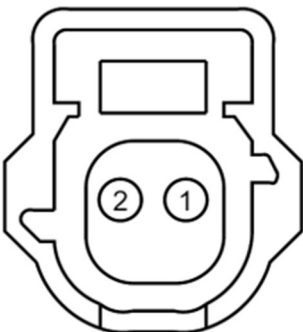

Circuit ID	AWG	Color	Function	Cavity <sup>1</sup>
VH407	20	BU	AAT	1
RE406	20	BK	SIGRTN	2

Ford Factory Shop Manual purchase options [www.motorcraftservice.com](http://www.motorcraftservice.com)



FORD PERFORMANCE

# M-6017-73M 7.3L Engine Control Pack Installation Instructions

NO PART OF THIS DOCUMENT MAY BE REPRODUCED WITHOUT PRIOR AGREEMENT AND WRITTEN PERMISSION OF FORD PERFORMANCE PARTS © Ford Motor Company 2020

## C1B – Inline from Control Pack Main Harness to Transmission Harness

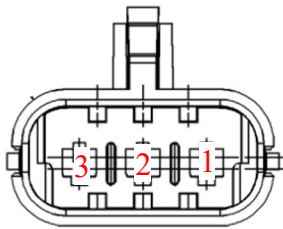

Circuit ID	AWG	Color	Function	Cavity
DCF08A	18	YE	Key On 12V/10A	1
VE807D	20	YE-VT	MAF	2
CE378D	20	GN-VT	VREF	3

## C146 – Inline from Control Pack Main Harness to Engine Harness

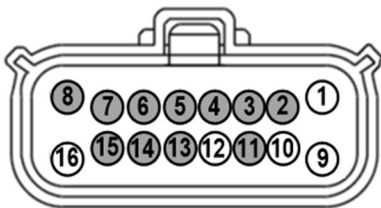

Circuit ID	AWG	Color	Function	Cavity
DCF04	16	GY	VPWR4	1
-	-	-	-	2
-	-	-	-	3
-	-	-	-	4
-	-	-	-	5
-	-	-	-	6
-	-	-	-	7
-	-	-	-	8
DCF06C	16	GN	VPWR6	9
-	-	-	-	11
SGD200E	16	BK	Ground Eyelet - CHASSY	12
-	-	-	-	13
-	-	-	-	14
-	-	-	-	15
DCF02	16	BU	VPWR2	16

## C160A – Inline to I/P Pigtail Connector

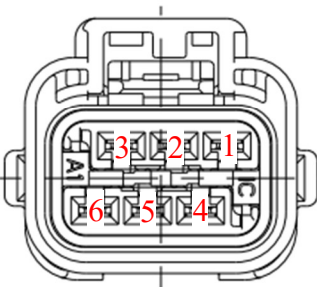

Circuit ID	AWG	Color	Function	Cavity
DCR04	12	GN	Fuel Pump Relay Out	1
CET43	20	GY	Shift UP	2
TS02	18	LIGHT BLUE	Starter Request (SMR)	3
CET42C	20	GN-VT	Shift DOWN - CPP	4
RT060	18	LIGHT GREEN	Ignition Relay Trigger (Toggle Switch)	5
RE472	20	BU	SIGRTN	6

Ford Factory Shop Manual purchase options [www.motorcraftservice.com](http://www.motorcraftservice.com)



FORD PERFORMANCE

# M-6017-73M 7.3L Engine Control Pack Installation Instructions

NO PART OF THIS DOCUMENT MAY BE REPRODUCED WITHOUT PRIOR AGREEMENT AND WRITTEN PERMISSION OF FORD PERFORMANCE PARTS © Ford Motor Company 2020

## C175B – PCM Connector (Control Pack Main Harness)

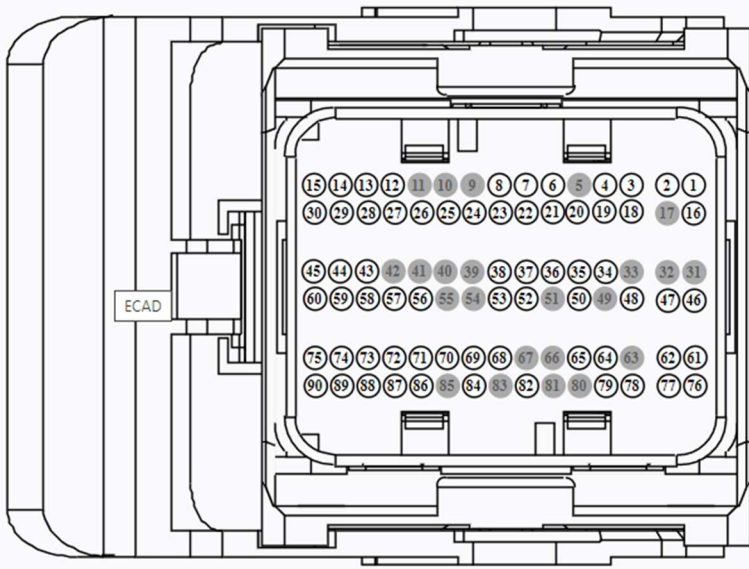

Circuit ID	AWG	Color	Function	Cavity
DCF01B	18	YE	VPWR1	1
DCF01C	18	YE	VPWR1	2
RT040	20	WH-YE	Fuel Pump Relay Trigger	3
RT020	20	WH-BU	Fan Relay Trigger	4
DCF05B	20	RD	PCM_WAKE	7
VDB05A	20	WH	HS CAN (-)	12
DCF05C	20	RD	ISP_R	13
DCF01D	18	YE	VPWR1	16
TS02	18	LIGHT BLUE	Starter Request (SMR)	22
VE740B	20	VT-GY	IAT	24
RE406	20	BK	SIGRTN	26
VDB04A	20	WH-BU	HS CAN (+)	27
MIL01	18	BK	Malfunction Indicator Lamp (MIL)	34
RT031	20	WH-OG	Starter Motor Control Sense (SMCS)	44
SGDPCMB1	18	BK	Ground Eyelet - Chassy	46
SGDPCMCI	18	BK	Ground Eyelet - Chassy	47
CET43	20	GY	Shift UP	53
VE701	20	YE	APP1 Signal	56
RE320C	20	BU	MAF Return	58
RT010	20	BN	PCMRC	60
SGDPCMD1	18	BK	Ground Eyelet - Chassy	61
SGDPCMB2	18	BK	Ground Eyelet - Chassy	62
CET42A	20	GN-VT	Shift DOWN - CPP	65
VE702	20	BU	APP2 Signal	68
LE137	20	BU	APP2 VREF	71
RE137	20	YE	APP2 RTN	72
RE472	20	BU	SIGRTN	73

Cont. on next page

Ford Factory Shop Manual purchase options [www.motorcraftservice.com](http://www.motorcraftservice.com)





FORD PERFORMANCE

# M-6017-73M 7.3L Engine Control Pack Installation Instructions

NO PART OF THIS DOCUMENT MAY BE REPRODUCED WITHOUT PRIOR AGREEMENT AND WRITTEN PERMISSION OF FORD PERFORMANCE PARTS © Ford Motor Company 2020

SGDPCMC2	18	BK	Ground Eyelet - Chassy	76
SGDPCMD2	18	BK	Ground Eyelet - Chassy	77
RT032	20	WH	Starter Moter Control (SMC)	78
VH407	20	BU	AAT	84
LE136	20	GN	APPI VREF	86
RE136	20	VT	APPI RTN	87

## 11.2 – Control Pack Transmission Harness

C1571 – UEGO (Universal Exhaust Gas Oxygen Sensor) RH (Bank 1)

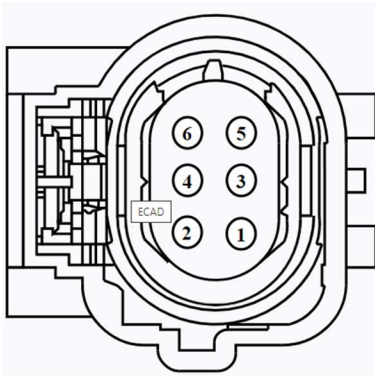

Circuit ID	AWG	Color	Function	Cavity
LE451	18	BN	UO2SIP-11	1
LE448	18	GY-BU	UREF-11	2
CE235	18	GN-OG	HTR-11	3
CBK02A	18	GN-BU	VPWR	4
LE452	18	GN	UO2SIA-11	5
VE826	18	YE-OG	UO2SN-11	6

C1572 – UEGO (Universal Exhaust Gas Oxygen Sensor) LH (Bank 2)

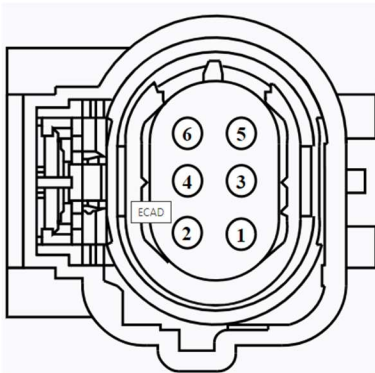

Circuit ID	AWG	Color	Function	Cavity
LE450	18	WT-VT	UO2SIP-21	1
LE449	18	WT-GY	UREF-21	2
CE236	18	GY-VT	HTR-21	3
CBK02B	18	GN	VPWR	4
LE453	18	BN-BU	UO2SIA-21	5
VE827	18	WH-GN	UO2SN-21	6

Ford Factory Shop Manual purchase options [www.motorcraftservice.com](http://www.motorcraftservice.com)



FORD PERFORMANCE

# M-6017-73M 7.3L Engine Control Pack Installation Instructions

NO PART OF THIS DOCUMENT MAY BE REPRODUCED WITHOUT PRIOR AGREEMENT AND WRITTEN PERMISSION OF FORD PERFORMANCE PARTS © Ford Motor Company 2020

C1A – Inline from Trans Harness to Control Pack Main Harness

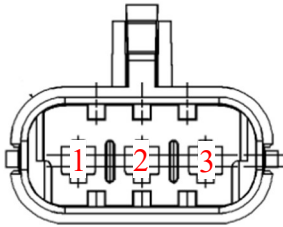

Circuit ID	AWG	Color	Function	Cavity
DCF08	18	RD	Key On 12V/10A	1
VE807B	20	YE-VT	MAF	2
CE378B	20	GN-VT	VREF	3

C90 – PCM Connector (Transmission Harness)

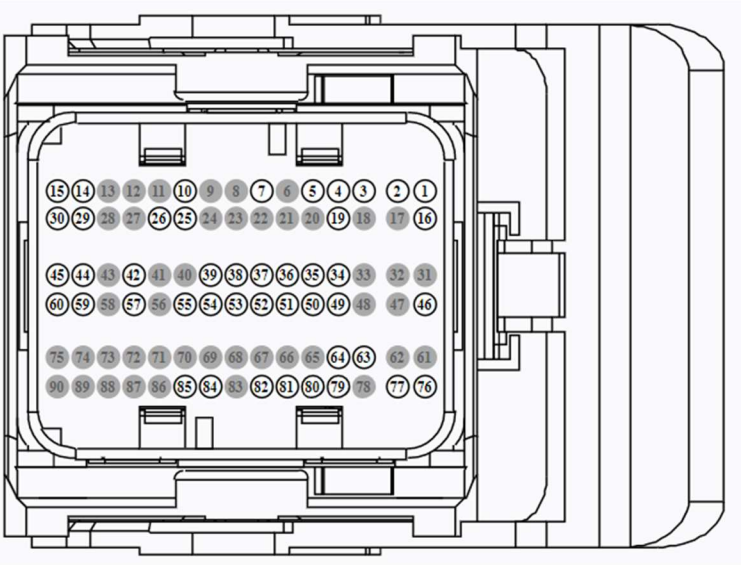

Circuit ID	AWG	Color	Function	Cavity
LE452	18	GN	UO2SIA11	14
LE453	18	BN-BU	UO2SIA21	15
LE451	18	BN	UO2SIP-11	29
LE450	18	WT-VT	UO2SIP-21	30
VE807B	20	YE-VT	MAF	39
LE448	18	GY-BU	UREF-11	44
LE449	18	WT-GY	UREF-21	45
CE236	18	GY-VT	HTR-21	46
VE826	18	YE-OG	UO2SN-11	59
VE827	18	WH-GN	UO2SN-21	60
CE235	18	GN-OG	HTR-11	76
CE378B	20	GN-VT	VREF	81

Ford Factory Shop Manual purchase options [www.motorcraftservice.com](http://www.motorcraftservice.com)



**FORD PERFORMANCE**

# M-6017-73M 7.3L Engine Control Pack Installation Instructions

NO PART OF THIS DOCUMENT MAY BE REPRODUCED WITHOUT PRIOR AGREEMENT AND WRITTEN PERMISSION OF FORD PERFORMANCE PARTS © Ford Motor Company 2020

## 11.3 – Engine Harness

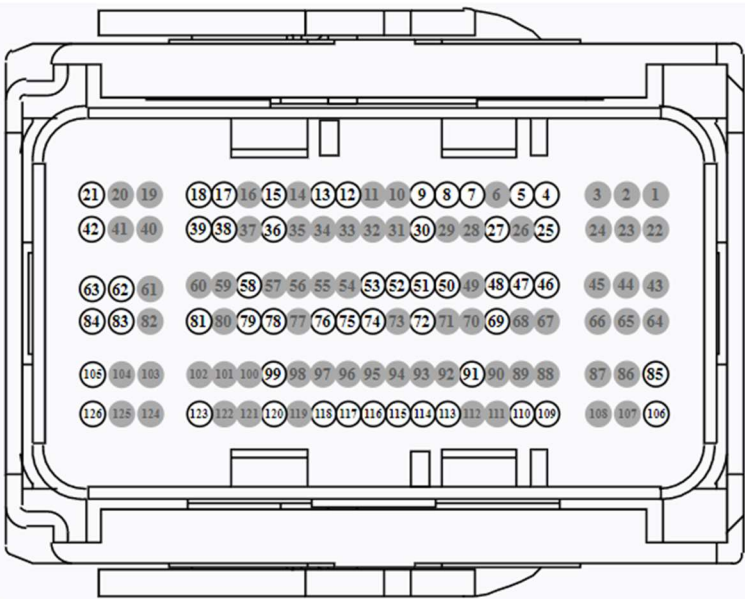

Pin	Circuit	Gauge	Circuit Function
4	CE421 (VT)	18	CTRL MOD. - POWERTRAIN # VARIABLE CAMSHAFT TIMING VALVE 1 (VCT 1)
5	RE407 (YE-VT)	18	CTRL MOD. - POWERTRAIN # SIGNAL RETURN COWL (C-SIGRTN) (SIGRTN-C)
7	CE617 (VT-GY)	20	RUNNER - INTAKE MANIFOLD CONTROL # MONITOR (IMRCM)
8	VE712 (BU-GY)	20	SENSOR - CYLINDER HEAD TEMPERATURE (CHT)
9	RE323 (WH-BN)	18	CTRL MOD. - POWERTRAIN # KNOCK SENSOR 1ST OR UNIQUE (KS1-)
12	VE818 (BN)	20	SENSOR - THROTTLE POSITION # NEGATIVE SLOPE (TP1-NS)
13	RE405 (GN-WH)	20	CTRL MOD. - POWERTRAIN # SIGNAL RETURN ENGINE (E-SIGRTN) (SIGRTN-A)
15	CE315 (BU)	20	CTRL MOD. - POWERTRAIN # INTAKE MANIFOLD RUNNER CONTROL VALVE (IMRC)
17	CE264 (YE-VT)	20	CTRL MOD. - POWERTRAIN # FUEL INJECTOR CONTROL FEED 3
18	CE267 (BU-GY)	20	CTRL MOD. - POWERTRAIN # FUEL INJECTOR CONTROL FEED 6
21	CE303 (WH-VT)	16	CTRL MOD. - POWERTRAIN # IGNITION COIL ON PLUG ASSEMBLY 1 (COP-A)
25	CE422 (YE-GY)	18	CTRL MOD. - POWERTRAIN # VARIABLE CAMSHAFT TIMING VALVE 2 (VCT2)
27	CE633 (YE-OG)	20	RUNNER - INTAKE MANIFOLD CONTROL # MONITOR (IMRCM)
30	VE801 (VT-OG)	18	SENSOR - KNOCK 1ST OR UNIQUE (KS1+)
36	CE263 (BU-GN)	20	CTRL MOD. - POWERTRAIN # FUEL INJECTOR CONTROL FEED 2
38	CE266 (VT-GN)	20	CTRL MOD. - POWERTRAIN # FUEL INJECTOR CONTROL FEED 5
39	CE262 (GN)	20	CTRL MOD. - POWERTRAIN # FUEL INJECTOR CONTROL FEED 1
42	CE308 (VT-BN)	16	CTRL MOD. - POWERTRAIN # IGNITION COIL ON PLUG ASSEMBLY 6 (COP-F)
46	CE113 (WH-BN)	18	CTRL MOD. - POWERTRAIN # CANISTER PURGE VALVE (CANP)
47	RE143 (VT)	18	CTRL MOD. - POWERTRAIN # CAMSHAFT SENSOR 1 -
48	CBK01 (BU)	20	FUSE - 15 OR CIRCUIT BREAKER (VPWR 1)
50	VE803 (BU-GN)	20	SENSOR - MANIFOLD ABSOLUTE PRESSURE (MAP) +
51	VE802 (BN-BU)	18	SENSOR - KNOCK 2ND (KS2+)
52	RE332 (YE-BU)	20	CTRL MOD. - POWERTRAIN # INTAKE AIR TEMP. SENSOR
53	VE828 (YE-OG)	18	SENSOR - KNOCK 1ST BANK 2ND
58	VE829 (GN-BU)	18	SENSOR - KNOCK 2ND BANK 2ND
62	CE307 (WH-BN)	16	CTRL MOD. - POWERTRAIN # IGNITION COIL ON PLUG ASSEMBLY 5 (COP-E)
63	CE305 (BU-OG)	16	CTRL MOD. - POWERTRAIN # IGNITION COIL ON PLUG ASSEMBLY 3 (COP-C)

Ford Factory Shop Manual purchase options [www.motorcraftservice.com](http://www.motorcraftservice.com)



FORD PERFORMANCE

## M-6017-73M 7.3L Engine Control Pack Installation Instructions

NO PART OF THIS DOCUMENT MAY BE REPRODUCED WITHOUT PRIOR AGREEMENT AND WRITTEN PERMISSION OF FORD PERFORMANCE PARTS © Ford Motor Company 2020

69	LE182 (VT-BN)	18	CTRL MOD. - POWERTRAIN # ENGINE OIL PRESSURE TRANSDUCER
72	RE324 (BN-GN)	18	CTRL MOD. - POWERTRAIN # KNOCK SENSOR 2ND (KS2-)
74	RE344 (GN)	18	CTRL MOD. - POWERTRAIN # KNOCK SENSOR 1ST BANK 2ND
75	VE738 (YE-BU)	18	SENSOR - CAMSHAFT POSITION BANK 2 EX
76	VE736 (WH-GN)	18	SENSOR - CAMSHAFT POSITION BANK 1 EX
78	VE711 (YE-VT)	18	SENSOR - CRANKSHAFT POSITION (CKP)
79	RE345 (VT-GY)	18	CTRL MOD. - POWERTRAIN # KNOCK SENSOR 2ND BANK 2ND
81	CE265 (WH)	20	CTRL MOD. - POWERTRAIN # FUEL INJECTOR CONTROL FEED 4
83	CE309 (YE-GY)	16	CTRL MOD. - POWERTRAIN # IGNITION COIL ON PLUG ASSEMBLY 7 (COP-G)
84	CE306 (GN-VT)	16	CTRL MOD. - POWERTRAIN # IGNITION COIL ON PLUG ASSEMBLY 4 (COP-D)
85	CE426 (BU-GN)	18	CTRL MOD. - POWERTRAIN # THROTTLE ACTUATOR CONTROL MOTOR (TACM-)
91	RE454 (YE-GN)	18	CTRL MOD. - POWERTRAIN # SIGNAL RETURN ENGINE #2
99	RE138 (BU-GN)	20	CTRL MOD. - POWERTRAIN # CYLINDER HEAD TEMPERATURE SENSOR
105	CE310 (BU-BN)	16	CTRL MOD. - POWERTRAIN # IGNITION COIL ON PLUG ASSEMBLY 8 (COP-H)
106	CE412 (YE-VT)	18	CTRL MOD. - POWERTRAIN # THROTTLE ACTUATOR CONTROL MOTOR (TACM+)
109	CE358 (GY-YE)	18	CTRL MOD. - POWERTRAIN # PUMP VARIABLE OIL
110	CE269 (GY-VT)	20	CTRL MOD. - POWERTRAIN # FUEL INJECTOR CONTROL FEED 8
113	RE135 (GN-BN)	18	CTRL MOD. - POWERTRAIN # CRANKSHAFT POSITION SENSOR (SIGRTN)
114	RE134 (BU-OG)	20	CTRL MOD. - POWERTRAIN # ELECTRONIC THROTTLE CONTROL (ETCRTN)
115	CE275 (BU-BN)	20	CTRL MOD. - POWERTRAIN # INTAKE MANIFOLD RUNNER CONTROL VALVE MONITOR 1 VREF
116	LE423 (GN-VT)	20	CTRL MOD. - POWERTRAIN # VOLTAGE REFERENCE ENGINE (VREF) (E-VREF) (VREF1)
117	LE134 (YE)	20	CTRL MOD. - POWERTRAIN # ELECTRONIC THROTTLE CONTROL (ETCREF)
118	LE423 (GN-VT)	18	CTRL MOD. - POWERTRAIN # VOLTAGE REFERENCE ENGINE (VREF) (E-VREF) (VREF1)
120	LE135 (GY-VT)	18	CTRL MOD. - POWERTRAIN # CRANKSHAFT POSITION SENSOR (VREF)
123	CE268 (BN-YE)	20	CTRL MOD. - POWERTRAIN # FUEL INJECTOR CONTROL FEED 7
126	CE304 (YE-BU)	16	CTRL MOD. - POWERTRAIN # IGNITION COIL ON PLUG ASSEMBLY 2 (COP-B)

Ford Factory Shop Manual purchase options [www.motorcraftservice.com](http://www.motorcraftservice.com)



FORD PERFORMANCE

# M-6017-73M 7.3L Engine Control Pack Installation Instructions

NO PART OF THIS DOCUMENT MAY BE REPRODUCED WITHOUT PRIOR AGREEMENT AND WRITTEN PERMISSION OF FORD PERFORMANCE PARTS © Ford Motor Company 2020

## 12.0 - CAN Message Definition

**NOTE:** There are two access point for use of HSCAN. See blunt cut circuits (Item G) and Connector (Item X).

Parameter	PCM Units	Rate (ms)	Rate (Hz)	PCM->CAN Conversion	Range	Resolution	Num Bits	Offset	Notes
ENGINE_SPEED	RPM	10	100	None	0-16383	1	14	0	
ENGINE_SPEED_HZ	Hz	10	100	rpm/60*100	0-163.83	0.01	14	0	0-9829 RPM
AF0	A/F	10	100	$((\lambda * \text{stoic\_ afr}) - 7.0) * 100$	7-27.47	0.01	11	7	Lambda converted to A/F based on Stoic A/F value
AF1	A/F	10	100	$((\lambda * \text{stoic\_ afr}) - 7.0) * 100$	7-27.47	0.01	11	7	Lambda converted to A/F based on Stoic A/F value
Fuel_Pressure	Kpa	10	100	psi * 6.89476	0-511	1	9	0	Rail on PFILift pump on DPFI
DI_Pressure	Kpa	10	100	psi * 6.89476	0-32768	1	15	0	Only on DI/DPFI engines
BOOST	Kpa	10	100	psi * 6.89476	0-511	1	9	0	Only On boosted engines, positive pressure only
VSPD	MPH	20	50	mph * 1.60934	0-409.5	0.1	12	0	
MAN_VAC	inHg	20	50	$((\text{inHg} * 3.38639) + 105) * 10$	-105-409.5	0.1	12	-105	Gauge pressure
ECT	degF	100	10	$(\text{degF} - 32) * 5/9$	-40-213	1	8	-40	214=degraded, 215=Failed
EOT	degF	100	10	$(\text{degF} - 32) * 5/9$	-40-213	1	8	-40	214=degraded, 215=Failed
EOP	Kpa	100	10		0-1023	1	10	0	
VBAT	volts	100	10	vbat * 100	0-20.47	0.01	11	0	
Codes_Count	-	100	10		0-255	1	8	0	
TOT	degF	100	10	$(\text{degF} - 32) * 5/9$	-40-213	1	8	-40	214=degraded, 215=Failed
Gear	-	100	10		0-15	1	4	0	
Shifter_Position	-	100	10		0-15	1	4	0	

Message ID	Transmitter	Rate (Hz)	Rate (ms)	Bit Number																																																																															
				Byte 0								Byte 1								Byte 2								Byte 3								Byte 4								Byte 5								Byte 6								Byte 7																							
0x270	PCM	100	10	Res	0	1	2	3	4	5	6	7	8	9	10	11	12	13	14	15	16	17	18	19	20	21	22	23	24	25	26	27	28	29	30	31	32	33	34	35	36	37	38	39	40	41	42	43	44	45	46	47	48	49	50	51	52	53	54	55	56	57	58	59	60	61	62	63															
0x274	PCM	50	20	Reserved								ENGINE_SPEED								BOOST								AF0								AF1								MAN_VAC								Res								DI_PRESSURE																							
0x275	PCM	50	20	reserved																																																																															
0x278	PCM	10	100	ECT								EOT								TOT								EOP								Res								Shifter_Position								CODES_COUNT								VBAT								R								Gear							

Ford Factory Shop Manual purchase options [www.motorcraftservice.com](http://www.motorcraftservice.com)





FORD PERFORMANCE

# M-6017-73M 7.3L Engine Control Pack Installation Instructions

NO PART OF THIS DOCUMENT MAY BE REPRODUCED WITHOUT PRIOR AGREEMENT AND WRITTEN PERMISSION OF FORD PERFORMANCE PARTS © Ford Motor Company 2020

## 13.2 - Automatic Transmission Harness

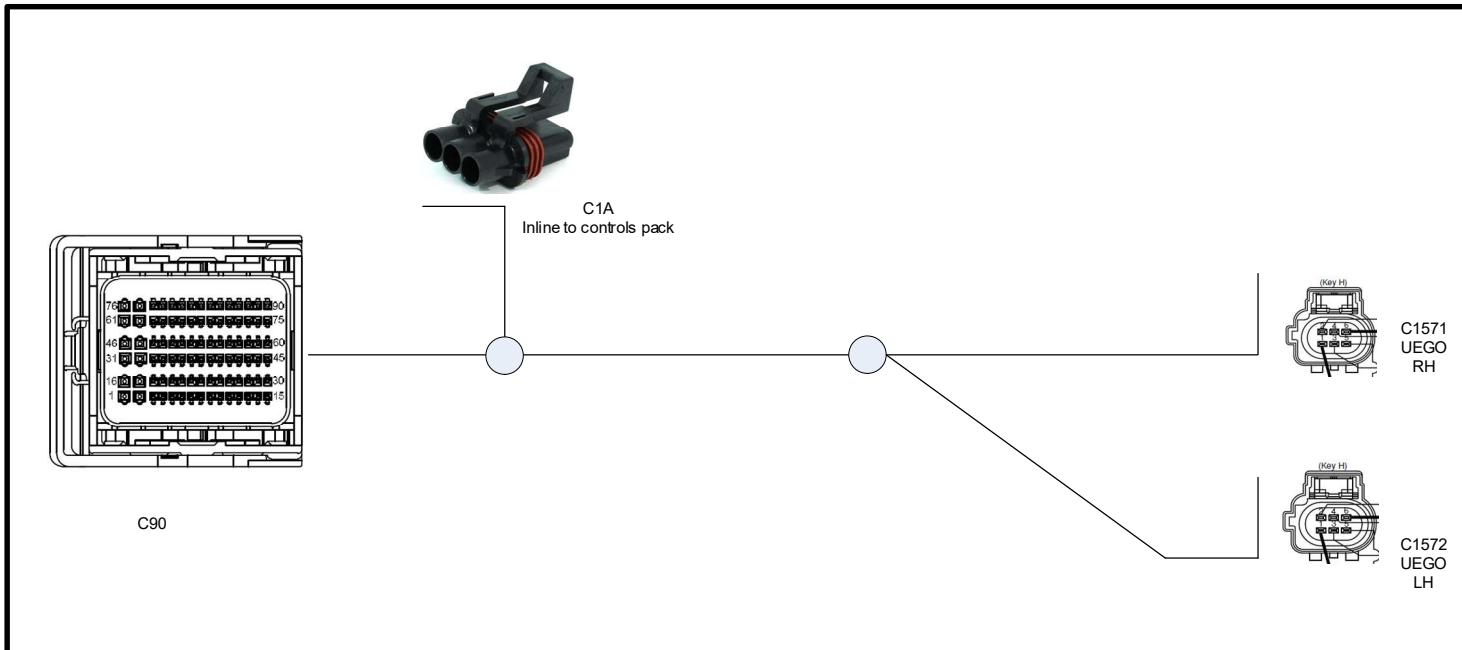

## 13.3 - Engine Starter system schematic

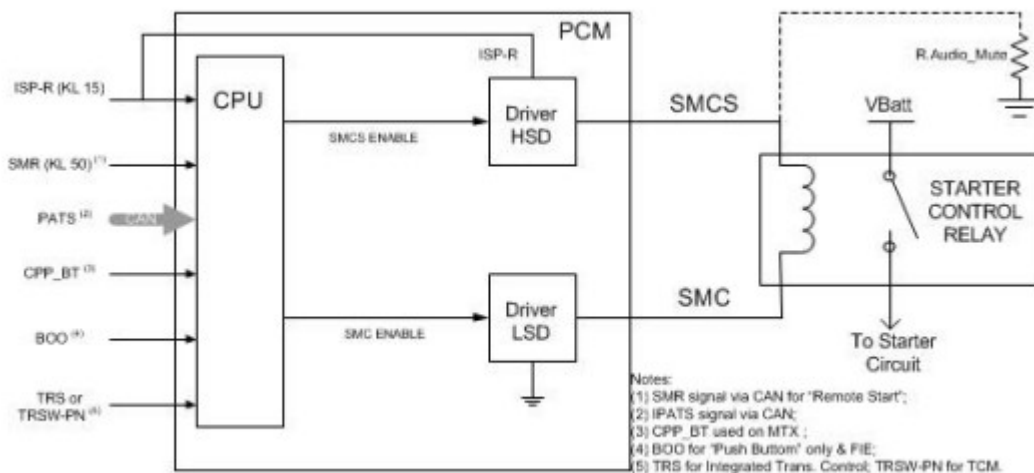

Ford Factory Shop Manual purchase options [www.motorcraftservice.com](http://www.motorcraftservice.com)