



FORD PERFORMANCE

Instruction Sheet

M-6017-M50A /504V 5.0L Controls Pack

NO PART OF THIS DOCUMENT MAY BE REPRODUCED WITHOUT PRIOR AGREEMENT AND WRITTEN PERMISSION OF FORD PERFORMANCE PARTS

Please visit www.performanceparts.ford.com for the most current instruction and warranty information.

PLEASE READ ALL OF THE FOLLOWING INSTRUCTIONS CAREFULLY PRIOR TO INSTALLATION. AT ANY TIME YOU DO NOT UNDERSTAND THE INSTRUCTIONS, PLEASE CALL THE FORD PERFORMANCE TECHLINE AT 1-800-367-3788

5.0L Controls Pack Installation Manual/Automatic



Factory Ford shop manuals are available from Helm Publications, 1-800-782-4356



FORD PERFORMANCE

Instruction Sheet

M-6017-M50A /504V 5.0L Controls Pack

NO PART OF THIS DOCUMENT MAY BE REPRODUCED WITHOUT PRIOR AGREEMENT AND WRITTEN PERMISSION OF FORD PERFORMANCE PARTS

TABLE OF CONTENTS

Section	Topic	Page
1.0	Introduction	2
2.0	Overview	2
3.0	Included/Possibly Required Components	2-7
4.0	Pre-Installation of Harness and Parts	8-11
5.0	Controls Pack Harness Installation Instructions	11-12
6.0	16-way I/P Pigtail Connection Details	13-14
7.0	Ford Performance Power Distribution Box Installation	14-15
8.0	Fuel System	15-17
9.0	Initial Start-Up	17
10.0	Wire Usage Schematics	17-19
11.0	Fuses & Relays	20
12.0	Troubleshooting Tips	20-21
13.0	Connector Faces	21-22

1.0 Introduction

This kit was developed by Ford Performance in order to allow performance enthusiasts the ability to install our 5.0L 4V TiVCT NA Crate Engine (Ford Performance P/N: M-6007-M50A) into the application of their choice. The system supports use of both manual and automatic transmission.

Note: Cruise control and air conditioning is not available with this system.

2.0 Overview

This booklet provides a step by step guide for the preparation and installation of the controls pack. Please read the instructions thoroughly before starting the installation. If you have any questions, contact Ford Performance Technical Support at (800) 367-3788.

3.0 Included/Possibly required Components

3.1 Powertrain Control Module (PCM) – CM-12A650-DRA(manual) / CM-12A650-CLB(automatic)

- The PCM is the central processing unit for engine operation. Input data/engine operation feedback is provided from each of the engine’s sensors connected to the PCM via wiring leads. This input data is used to perform

Factory Ford shop manuals are available from Helm Publications, 1-800-782-4356



FORD PERFORMANCE

Instruction Sheet

M-6017-M50A /504V 5.0L Controls Pack

NO PART OF THIS DOCUMENT MAY BE REPRODUCED WITHOUT PRIOR AGREEMENT AND WRITTEN PERMISSION OF FORD PERFORMANCE PARTS

- calculations that in turn adjust fuel quantity and spark timing according to varying driver demand (ie – accelerator pedal input).
- The wiring that plugs into the PCM is integral to the wiring harness that was included with your 5.0L crate engine, the length of these wiring leads dictate that mounting location be in close proximity to the engine itself.
- The PCM in this Controls Pack has a custom software and calibration dataset which were specifically modified/developed by Ford Performance engineers to provide peak performance and reliability with the 5.0L 4V TiVCT NA Crate Engine (Ford Performance P/N: M-6007-M50A)



PCM Calibration Application Notes:

- The calibration provided in this PCM will NOT work with the 'Returnless' fuel system as used on factory Mustang vehicles. Use of a return style fuel system is required. Refer to Section 8 of this manual for more information on fuel system requirements for this PCM.
- The Air Filter Assembly with Integral Mass Air Flow Sensor included with this kit must be used to achieve acceptable engine performance. If air filter assembly provided is not used, calibration will be required. Refer to Section 3.6 for more information about Air Inlet System requirements.
- Premium Fuel Only (91 Octane or higher).

NOTE: Due to the fuel system requirement described above, installation of this PCM in ANY Production Mustang vehicle will result in a no-start condition!

3.2 Accelerator Pedal Position Sensor (APPS) – CR3Z-9F836-C

- The accelerator pedal assembly includes a pair of integrated pedal position sensors (APPS1/APPS2). This pedal has electrical properties designed specifically for correct interface with PCM and is required for proper engine operation.

Factory Ford shop manuals are available from Helm Publications, 1-800-782-4356



FORD PERFORMANCE

Instruction Sheet

M-6017-M50A /504V 5.0L Controls Pack

NO PART OF THIS DOCUMENT MAY BE REPRODUCED WITHOUT PRIOR AGREEMENT AND WRITTEN PERMISSION OF FORD PERFORMANCE PARTS



3.3 Clutch Pedal Position Switch: Bottom Travel (CBT) - 6G9Z-11A152-A (Gray Plunger)



(CBT)

Note: Clutch switch is intended for manual transmission use ONLY. For automatic transmission use please cut off the CBT connector C257 and seal the wires. Refer to section 4.4 for more details on how to cap off unused connectors.

- The switch translates the clutch pedal position to the PCM.
- The bottom travel switch also acts as a starter safety interlock. The starter motor will not energize until the clutch has been fully depressed.
- CBT switch is Normally Open (IE – Clutch Pedal NOT fully depressed); Closed with Clutch Pedal fully depressed
- Clutch pedal assembly P/N: BV61-7B633-AA is available through an Authorized Ford Parts dealer. Includes a clutch pedal and mounting bracket with provisions to hold both the Top and Bottom of Travel switches in the appropriate locations.

WARNING: DO NOT BYPASS THE STARTER INTERLOCK. DOING SO CREATES A HAZARD TO THOSE IN AND AROUND THE VEHICLE AS THE STARTER CAN OPERATE WITH THE TRANSMISSION IN GEAR AND THE CLUTCH PEDAL ENGAGED.

3.4 Universal Exhaust Gas Oxygen Sensor (UEGO) – FR3Z-9F472-C(RIGHT HAND), FR3Z-9F472-E(LEFT HAND)

- Two UEGO sensors provide wide range feedback to the PCM for closed loop air fuel ratio control by measuring the quantity of oxygen present in exhaust leaving the combustion chamber.
- Each UEGO is supplied with a light coating of anti-seize lubricant on its threads. Please use caution when installing as this lubricant will damage the sensor element, so make sure no lubricant comes in contact with the sensor element (tip).
- Tighten to 48 Nm (35 lb-ft).

Factory Ford shop manuals are available from Helm Publications, 1-800-782-4356



FORD PERFORMANCE

Instruction Sheet

M-6017-M50A /504V 5.0L Controls Pack

NO PART OF THIS DOCUMENT MAY BE REPRODUCED WITHOUT PRIOR AGREEMENT AND WRITTEN PERMISSION OF FORD PERFORMANCE PARTS

NOTE: Do not splice, lengthen or otherwise modify the UEGO wiring. Doing so will adversely affect the sensor performance & reliability of the signal.



The engine harness and controls package M-6017-M50A is designed to operate with the UEGO sensors in the 2015 Mustang GT stock locations. Moving the UEGO sensors to alternate locations can result in the need to recalibrate the PCM.

Here are some tips if sensors have to be relocated:

The best option is to locate the sensor so it is sampling from all 4 cylinders and at a distance that does not require modification of the UEGO harness.

NOTE: Modification of the UEGO harness can affect function of UEGO sensor.

If your header design will not allow you to sample all 4 cylinders without UEGO harness modifications, a better alternative is locating the UEGO sensor to sample from a single cylinder. The cylinders that have (on average) the closest A/F ratio to the bank average are cylinder #4 (on bank 1) and cylinder #7 (on bank 2). If that's not possible due to packaging constraints, the next best choices are cylinder #3 (on bank 1) and cylinder #8 (on bank 2). Calibration required!

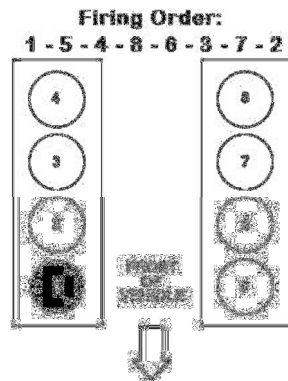

3.5 Plastic Bag of Assorted Items

- Buss 250A In-line Fuse
- Fuse holder

Factory Ford shop manuals are available from Helm Publications, 1-800-782-4356



FORD **PERFORMANCE**

Instruction Sheet

M-6017-M50A /504V 5.0L Controls Pack

NO PART OF THIS DOCUMENT MAY BE REPRODUCED WITHOUT PRIOR AGREEMENT AND WRITTEN PERMISSION OF FORD PERFORMANCE PARTS

- Malfunction Indicator Light



3.6 Air Cleaner Assembly with Integral Mass Air Flow Sensor – FR3Z-9600-B, FR3Z-9B659-C, FR3Z-9F763-B



IMPORTANT NOTE: The calibration of the PCM you have received requires use of this air box/MAF sensor system exactly as received. Any changes to the air inlet system will result in changes to how the air entering the engine is measured and will require modification to the PCM's calibration.

Ford Performance recognizes that it may not be practical to package this Air Box/MAF sensor system in some vehicle applications. The recommendations listed below are intended to serve as guidelines for designing an air inlet system that will provide good control system performance once the control system calibration has been modified to work with the new Air Inlet System:

1. **Flow Profile:** the MAF sensor should be located on a straight section of zip tube where the flow profile is generally uniform. If the sensor cannot be located on a straight section put the sensor on the outside radius of the inlet so the sensor is located in the higher flow velocity area.

Factory Ford shop manuals are available from Helm Publications, 1-800-782-4356



FORD PERFORMANCE

Instruction Sheet

M-6017-M50A /504V 5.0L Controls Pack

NO PART OF THIS DOCUMENT MAY BE REPRODUCED WITHOUT PRIOR AGREEMENT AND WRITTEN PERMISSION OF FORD PERFORMANCE PARTS

2. Flow Area: Keep the cross sectional area of the MAF sensor tube as close as possible to the cross sectional area of the original induction system.
3. Flow quality: minimize flow direction changes and maintain smooth tubing to minimize air flow disturbances and turbulence.
4. Flow pulsation: install sensor at least 6 to 8 inches upstream of the throttle body.
5. Transient performance: installing the sensor too far upstream of the throttle body (>24 inches) will result in transient lean/rich spikes due to the additional amount of time required for the measured air flow to travel from the MAF sensor to the intake manifold.
6. MAF sensor contamination: A) install sensor in upper half of cross sectional area to minimize possibility of condensation coming in contact with the MAF sensor element. In other words, if a clock is superimposed on a cross section of the zip tube, the sensor should be installed somewhere equal to or above the 9:00 and 3:00 positions. Most OEM applications have the sensor located at the 9:00 or 3:00 location. B) Sensor must be installed downstream of air filter and upstream of crank case ventilation inlet. Ideally, sensor should be located 3 diameters upstream of the crank case ventilation inlet.

3.7 Shifter assembly with cable(not included in this kit, available in our power module kit)

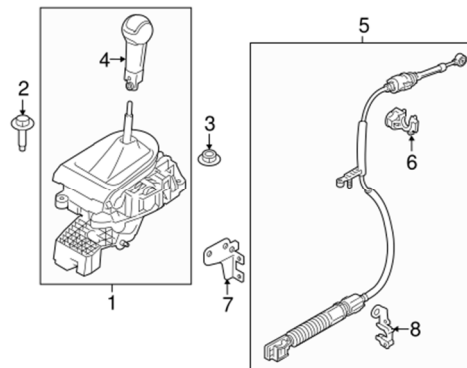

- Cable assembly(select level control) – FR3Z-7E395-A
- Level(gear shift) – FR3Z-7210-DB
- Bracket – FR3Z-7B229-A
- Bolts and nuts

3.8 Controls Pack Wiring Assembly – CM-14A006-A504VB

- Connects to vehicle battery and inline connector on engine harness
- Contains Ford Performance Power Distribution Box (FPPDB) and High Power 250A inline fuse
- Electrical connections to Accelerator Pedal (APPS) and Clutch Switch (CBT)
- Wire leads for Ignition Switch & Starter,
- Data Link Connector for reading Diagnostic Trouble Codes (DTCs)
- Check Engine/Malfunction Indicator Lamp (MIL) for visual indication of engine control system fault code presence
- MIL will stay illuminated when the ignition is ON and the engine is NOT running; therefore this condition does not indicate a system fault; Not all DTCs will cause the MIL to illuminate
- MIL on stock instrument panel will not work—only the MIL included in this kit will illuminate if a fault exists.

Factory Ford shop manuals are available from Helm Publications, 1-800-782-4356



FORD PERFORMANCE

Instruction Sheet

M-6017-M50A /504V 5.0L Controls Pack

NO PART OF THIS DOCUMENT MAY BE REPRODUCED WITHOUT PRIOR AGREEMENT AND WRITTEN PERMISSION OF FORD PERFORMANCE PARTS

4.0 Pre-Installation of Harness and Parts

4.1 Planning

The following is a list of key factors to consider before any installation takes place:

- PCM mounting location is limited by the lengths of the (2) corresponding leads into which the PCM is connected. These leads are an integral part of the CRATE ENGINE HARNESS (not included with Controls Pack)
- Ford Performance Power Distribution Box must be mounted within 60" of the vehicle battery as dictated by the Battery+ / Ground Lead Lengths of the controls pack wiring harness
- Lay out the harness and components first in order to ensure that the wiring leads will reach everywhere you intend them to. This is a good reality check before you drill any holes or mount any components!

4.2 Connector ID

Item	Connector #	Description	Item	Connector #	Description
A	-	UEGO	O	-	Blunt Cut Cooling Fan Lead
B	-	Battery ground BL	P	C400	2-way ICP for optional supercharger
C	-	FPPDB	Q	C102A	Alternator
D	-	Firewall Grommet	R	C128	MAF
E	GD200	Ground	S	C160B	16-way I/P Pigtail Connector
F	C160A	Inline to I/P Pigtail Connector	T	C175B	103-way Cowl Pocket Connector
G	C2040	APPS	U	C146	Inline to 12C508 (Engine Harness)
H	C257	Clutch Bottom of Travel	-	-	-
I	-	-	-	-	-
J	GD100	Ground	-	-	-
K	C251	Data Link Connector/OBD2	-	-	-
L	-	-	-	-	-
M	-	EPAS connections(optional)	-	-	-
N	-	Starter Lead	-	-	-

Table 1 – Summary of Controls Pack Connectors

Factory Ford shop manuals are available from Helm Publications, 1-800-782-4356



FORD PERFORMANCE

Instruction Sheet

M-6017-M50A /504V 5.0L Controls Pack

NO PART OF THIS DOCUMENT MAY BE REPRODUCED WITHOUT PRIOR AGREEMENT AND WRITTEN PERMISSION OF FORD PERFORMANCE PARTS

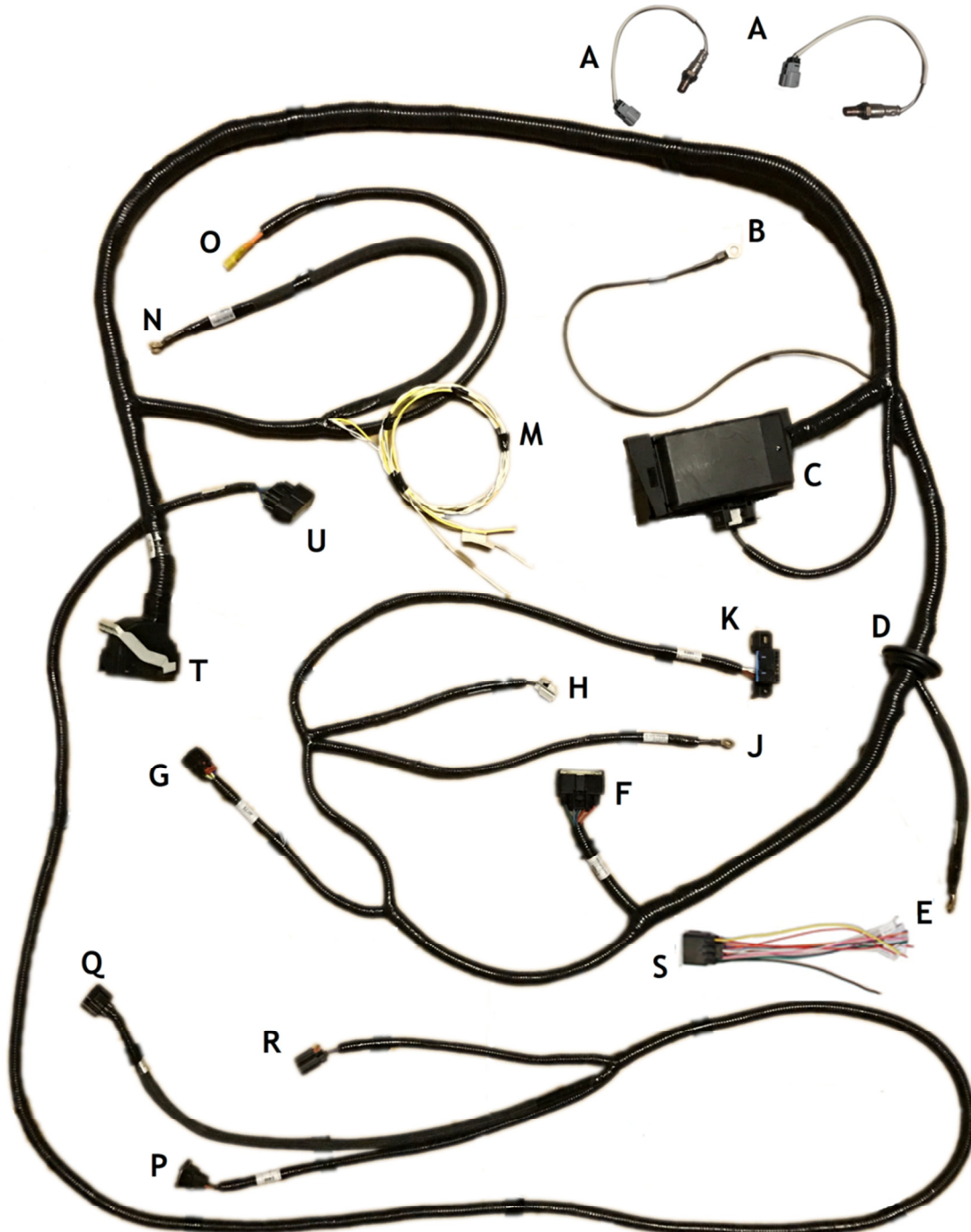

Figure 1 - Controls Pack Wiring Harness Components

Factory Ford shop manuals are available from Helm Publications, 1-800-782-4356



FORD PERFORMANCE

Instruction Sheet

M-6017-M50A /504V 5.0L Controls Pack

NO PART OF THIS DOCUMENT MAY BE REPRODUCED WITHOUT PRIOR AGREEMENT AND WRITTEN PERMISSION OF FORD PERFORMANCE PARTS

4.3 Tools Required

- Wire Cutter/Stripping Tool
- Crimper
- Digital Volt/Ohm Meter
- Solder Gun / Solder
- Center Punch
- Cordless Drill / Drill bits / Hole saw / Screwdriver bits

4.4 Cap off the Unused Supercharger Intercooler Connector if Applicable

If your vehicle is not supercharged, locate the 2-way ICP (Item P, Connector C400, Controls Pack Wiring Harness) and cut the wires leading to the connector and tape each wire, or place shrink tube over it, INDIVIDUALLY. This is very important in order to ensure that you do not inadvertently short a hot and ground lead together, causing damage to your PCM and/or other sensitive electronics.

4.5 Engine Harness Routing (Automatic)

Rear View of Engine:

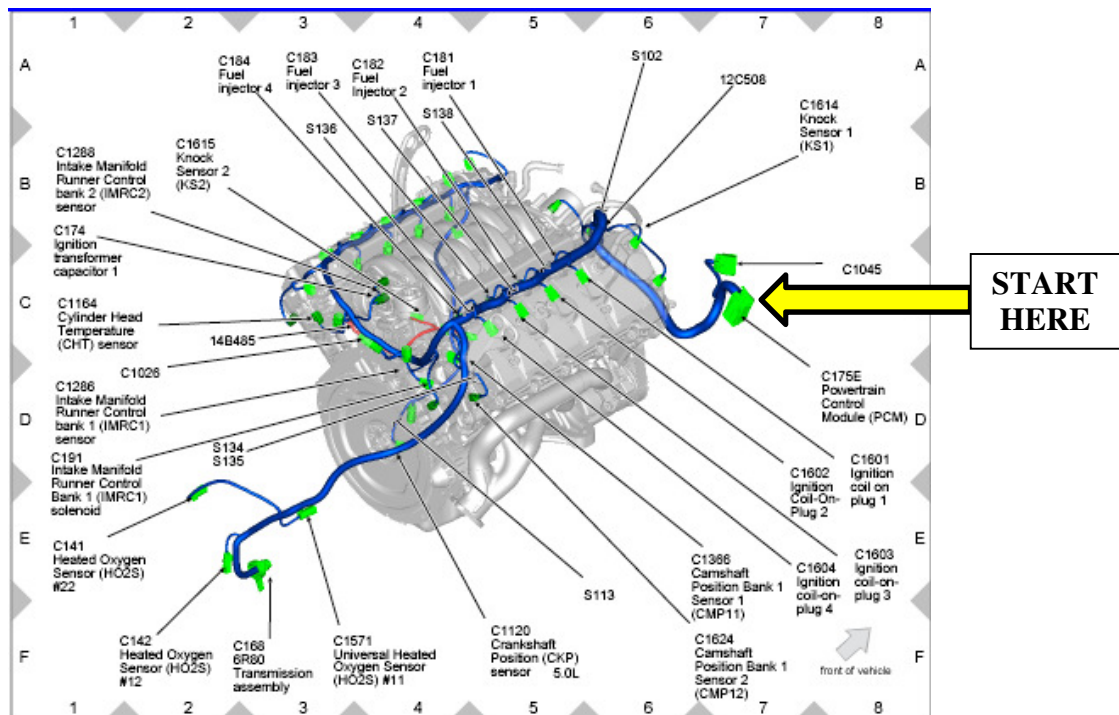

Figure 2 – Rear View of Engine.

Note: The wire harness shown in blue above is the ENGINE harness (FU5Z-12A581-E) that comes standard with the 5.0L 4V TiVCT NA Crate Engine (Ford Performance P/N: M-6007-M50A); THIS IS NOT THE CONTROLS PACK WIRING HARNESS. The automatic

Factory Ford shop manuals are available from Helm Publications, 1-800-782-4356



FORD PERFORMANCE

Instruction Sheet

M-6017-M50A /504V 5.0L Controls Pack

NO PART OF THIS DOCUMENT MAY BE REPRODUCED WITHOUT PRIOR AGREEMENT AND WRITTEN PERMISSION OF FORD PERFORMANCE PARTS

engine harness comes with the connection to transmission assembly(C168) which can be plugged into 2015-2017 mustang transmission. The manual engine harness DOES NOT have this connector and O2 sensor mounting locations are different.

Front View of Engine:

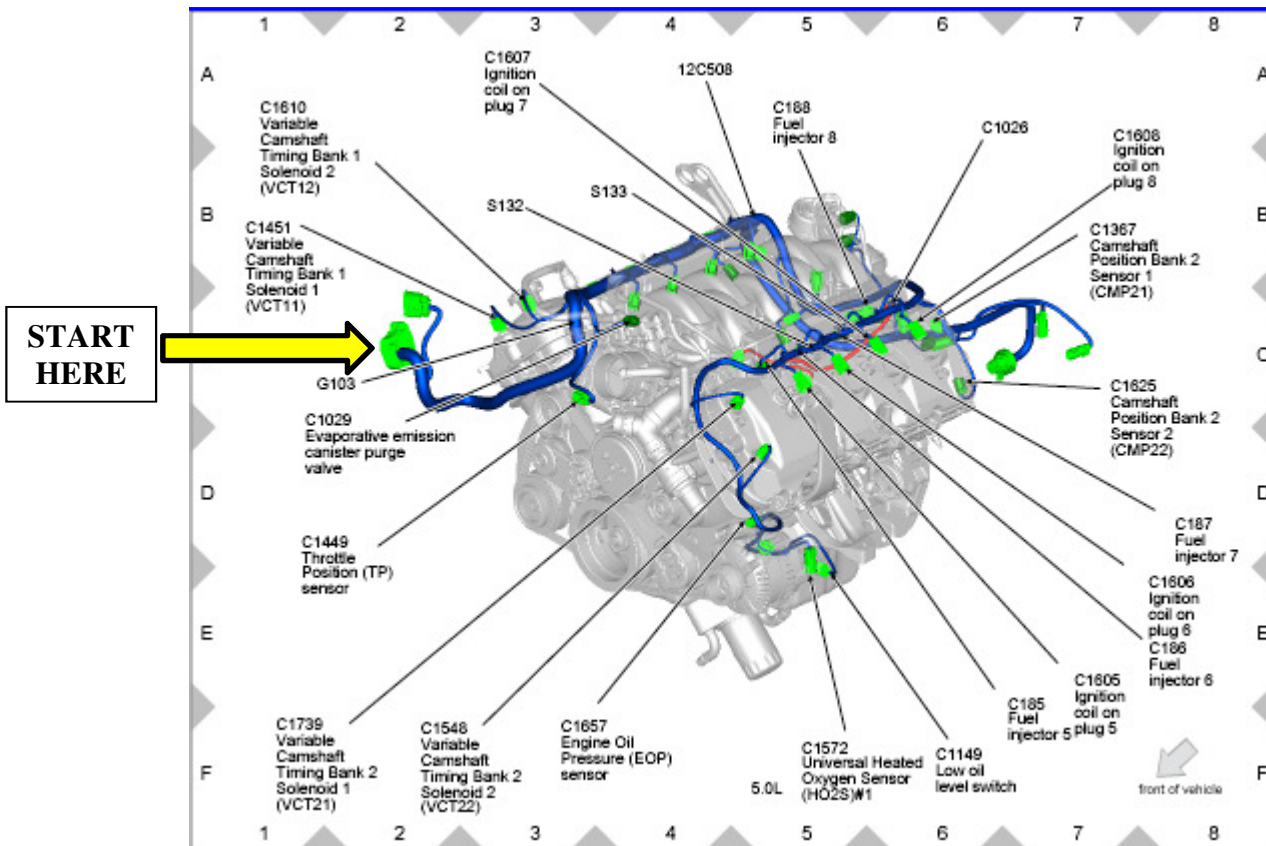

Figure 3 – Front View of Engine.

Note: The wire harness shown in blue above is the ENGINE harness that comes standard with the 5.0L 4V TiVCT NA Crate Engine (Ford Performance P/N: M-6007-M50A); THIS IS NOT THE CONTROLS PACK WIRING HARNESS.

Factory Ford shop manuals are available from Helm Publications, 1-800-782-4356



FORD PERFORMANCE

Instruction Sheet

M-6017-M50A /504V 5.0L Controls Pack

NO PART OF THIS DOCUMENT MAY BE REPRODUCED WITHOUT PRIOR AGREEMENT AND WRITTEN PERMISSION OF FORD PERFORMANCE PARTS

5.0 Controls Pack Harness Installation Instructions

NOTE: To avoid electrical shock and/or damage to sensitive electrical control system components, before beginning any work, remove the vehicle's Negative Battery Terminal and place a rag or towel between it and the Battery Negative Post. The Negative Battery Terminal is not to be reinstalled until the last step of installation.

1. Identify proper mounting location for the PCM, Power Distribution Box (Item C) & Inline Fuse Holder. Locate the PCM connector (C175E) on the engine harness as indicated in Figures 2 and 3 by the "START HERE" arrow.
2. If a stock PCM is present (crate engines do NOT include a stock PCM, only the controls pack PCM), unplug it and store it in a cool, dry place in case it is needed in the future.
3. Plug C175E (from the engine harness) and C175B (Item T from the controls pack harness) into the controls pack PCM: FR3Z-12A650-EGC; once plugged-in, use a zip-tie to tie the bundle of wires exiting each connector back together. In the steps that follow, we will be repeating this process of using zip-ties to piggy-back/tie the controls pack harness to the existing engine harness approximately every 200 mm or so along the engine harness.
4. Connect the in-line connector (C146) from the controls pack harness to the mating connector on the engine harness.
5. Connect Alternator Connector (C102A), Mass Air Flow (MAF) Sensor Connector (C128) and Intercooler connector for supercharger (C400) to their respective locations being sure to avoid any pinch-points or exhaust hot-spots.
6. Connect Blunt-cut orange 10AWG cooling fan lead and Starter Lead Eyelet to their respective locations.
7. The grommet needs to be properly installed in the firewall of your vehicle so as to protect the controls pack harness routing that passes through to the passenger compartment. All connections previously mentioned are located under hood; all connections mentioned from this point on are located in the passenger compartment.
8. Identify proper mounting location for the Accelerator pedal, Clutch Bottom of Travel (purchased separately) and Ignition Switch (purchased separately).
9. Identify mounting location for the Bracket with OBDII connector and Malfunctioning Light.
10. Connect the ground eyelet (Item E) to a reliable ground point on the chassis or engine block, away from dirt and water.
11. Route C160A to approximately the base of the steering wheel to be connected later.
12. Connect each of the connectors to their respective locations mentioned above (C2040, C257) and Ground eyelet for Data Link Connector (Item J) to a reliable ground position.
13. Locate the 16-way I/P Pigtail connector with blunt leads (Item S) and continue to Section 6.

*** Removal Procedures for Unused Connectors:**

If 100% sure connector is not currently needed and will not be needed in the future, cut routing leading-up to unused connector and individually heat shrink each wire herein. To ensure that the wires are completely isolated from one another and the outside environment, you may also want to wrap the heat-shrunked wire in electrical tape to provide an additional layer of protection from moisture and dirt.

Factory Ford shop manuals are available from Helm Publications, 1-800-782-4356



FORD PERFORMANCE

Instruction Sheet

M-6017-M50A /504V 5.0L Controls Pack

NO PART OF THIS DOCUMENT MAY BE REPRODUCED WITHOUT PRIOR AGREEMENT AND WRITTEN PERMISSION OF FORD PERFORMANCE PARTS

6.0 16-way I/P Pigtail Connection Details

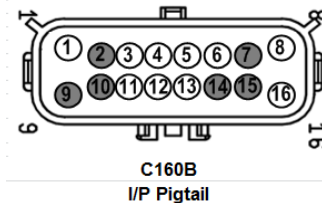
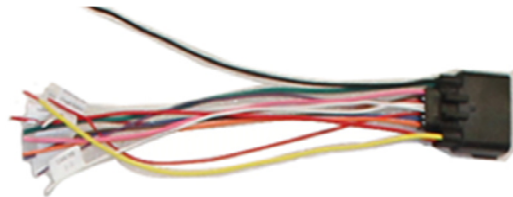

The 16-way pigtail is to be connected according to the chart below. See also the diagrams on the following pages for illustrations of wire connection points, based on the ignition/starter switches that you intend to use. Setup A uses separate toggle switches for ignition and starter inputs, while Setup B uses an ignition cylinder with a key.

Cavity	Lead Label	Wire Color	Description
1	Fuel Pump Relay Out	GN	Provides +12V to the fuel pump
2	-	-	-
3	Starter Motor Request (SMR)	Light Blue	Apply +12V to send a request to the PCM to energize the starter solenoid
4	Malfunction Indicator Lamp (MIL)	BU	Provides ground to MIL when error state is present
5	Ignition Relay Trigger	Light Green	Apply +12V to energize the ignition relay/wake-up the system
6	MIL Power B+	RD	Provides constant +12V to MIL
7	-	-	-
8	HAAT B	RD	Provides constant +12V
9	Chassis Ground	BK	Provides extra ground, if needed
10	-	-	-
12	-	-	-
13	-	-	-
16	-	-	-

- 6.1 Locate each of the Blunt Leads. This is where you will need to make all of the soldered connections for the harness. Before soldering any wires, however, you must first decided which set-up you will pursue by referencing Set-up A and Set-up B on pages 19 and 20. Once you've decided on your set-up, continue to Step 6.2.
- 6.2 Connect the following REQUIRED blunt leads as follows:
 - 6.2.1 **Blunt Lead 1 – Fuel Pump Relay Out (Dark Green):** Connect to Fuel Pump positive. Separate ground for fuel pump must be provided. The fuel pump will start running any time key is on, then if you don't start the engine the computer will turn it off after a couple of seconds.

Factory Ford shop manuals are available from Helm Publications, 1-800-782-4356



FORD PERFORMANCE

Instruction Sheet

M-6017-M50A /504V 5.0L Controls Pack

NO PART OF THIS DOCUMENT MAY BE REPRODUCED WITHOUT PRIOR AGREEMENT AND WRITTEN PERMISSION OF FORD PERFORMANCE PARTS

6.2.2 **Blunt Lead 3 – Starter Motor Request (Light Blue):**

Set-up A:

Connect to input node of starter momentary switch so that 12 volts is provided when engine starting is requested.*

Set-up B:

Connect to 'Start' output node of ignition cylinder so that 12 volts is provided when engine starting is requested.*

6.2.3 **Blunt Lead 4 – Malfunction Indicator Light (Blue):** Connect this blunt lead to the negative (black) lead on the MIL (provided in the kit bag).

6.2.4 **Blunt Lead 5 – Ignition Relay Trigger (Light Green):**

Set-up A:

Connect this wire to the output side of the ignition toggle switch so that 12 volts is provided when the key is in the 'Start' (cranking) and 'Run' positions. It is imperative that this circuit be reliable, the PCM will interpret an intermittent voltage on this signal as a request to shut down the engine! (Hint, if your engine shuts down after a hard launch check here first).

Set-up B:

Connect to the 'Start/Run' output node of ignition cylinder so that 12 volts is provided when engine starting is requested. It is imperative that this circuit be reliable, the PCM will interpret an intermittent voltage on this signal as a request to shut down the engine! (Hint, if your engine shuts down after a hard launch check here first).

6.2.5 **Blunt Lead 6 – MIL Power B+ (RED):** Connect this blunt lead to the positive (red) lead of the MIL.

6.2.6 **Blunt Lead 8 – Hot At All Times (Red):**

Set-up A:

Connect this lead to two different locations as needed: 1) the input node of the Starter momentary switch, and 2) the input node of the Ignition toggle switch.

Set-up B:

Connect this lead to locations as needed: 1) the input node of the ignition cylinder.

6.3 Once all of the blunt lead connections have been soldered onto their appropriate location, insert the 16-way I/P Pigtail connector into C160A.

* **Important Note on the Starting System**

This kit includes connections and installation instructions for PCM controlled engine starting; however, it is not required that the customer utilize this option. Customers may choose to use their existing non-PCM controlled starting system if desired. If non-PCM controlled starting is used, Step 6.2.2 may be omitted, and any unused blunt leads should be cut to ~2" length and sealed using heat shrink.

Factory Ford shop manuals are available from Helm Publications, 1-800-782-4356



FORD PERFORMANCE

Instruction Sheet

M-6017-M50A /504V 5.0L Controls Pack

NO PART OF THIS DOCUMENT MAY BE REPRODUCED WITHOUT PRIOR AGREEMENT AND WRITTEN PERMISSION OF FORD PERFORMANCE PARTS

7.0 Ford Performance Power Distribution Box Installation

- 7.1. Before you start, you should have your two battery jumper cables at hand (purchased separately, 4 AWG recommended), one from Battery to fuse holder, the other one from fuse holder to FPPDB.
- 7.2. Carefully remove the nut and washers on both terminals of the in-line fuse holder and set aside.
- 7.3. Use one of your battery cables and place the eyelet onto one of the two in-line fuse holder terminals, then one of the washers, and then tighten down with one of the two nuts.

- 7.4. Locate the power terminal of the side of FPPDB, notice there is a battery positive blunt lead eyelet already attached to it. Attach the other eyelet to this power terminal by tightening the nut down on top of the eyelet. The order of installation on the power terminal should be a washer, the battery cable eyelet, then the blunt lead eyelet, another washer, and then the nut. Avoid sharp points and using zip-ties to secure the cable (approximately every 200 mm) along the way. **DO NOT CONNECT ANYTHING TO THE BATTERY YET.**
- 7.5. Place the Buss 250A fuse onto the fuse holder terminals.
- 7.6. On the opposite in-line fuse holder terminal, place one eyelet of your second battery cable, then the other remaining washer, and then tighten down with the remaining nut.
- 7.7. Close the cover of the in-line fuse holder.
- 7.8. Being careful not to inadvertently complete the circuit, connect the opposite end of the battery cable to the positive terminal of the vehicle battery.

Note: This lead **MUST** be hot at all times (HAAT). If this lead is connected through a switch, the Keep Alive Memory (KAM) of the PCM will be cleared whenever the switch is opened. This will result in loss of diagnostic trouble codes, adaptive fuel parameters, and other information stored in KAM by the PCM.

- 7.9. Install and tighten the Negative Battery Terminal (not included in kit) onto the Vehicle Battery. Attach the ground blunt lead to the Negative Battery Terminal (you will need to provide the eyelet). Verify that you have a good reliable (dry and clean) ground path from the battery negative post to the chassis ground. In general, the resistance from the battery ground to this chassis location should be less than 0.1 ohm.

8.0 Fuel System

The PCM is calibrated for a return style fuel system as shown below.

- Set regulator to maintain 55 psi delta fuel pressure across injector (55 psi at fuel rail with engine off):
- Use only AN type fuel fitting to interface with OEM fuel rail.

- Fuel pressure regulator must have reference to manifold vacuum.

Factory Ford shop manuals are available from Helm Publications, 1-800-782-4356



FORD **PERFORMANCE**

Instruction Sheet

M-6017-M50A /504V 5.0L Controls Pack

NO PART OF THIS DOCUMENT MAY BE REPRODUCED WITHOUT PRIOR AGREEMENT AND WRITTEN PERMISSION OF FORD PERFORMANCE PARTS

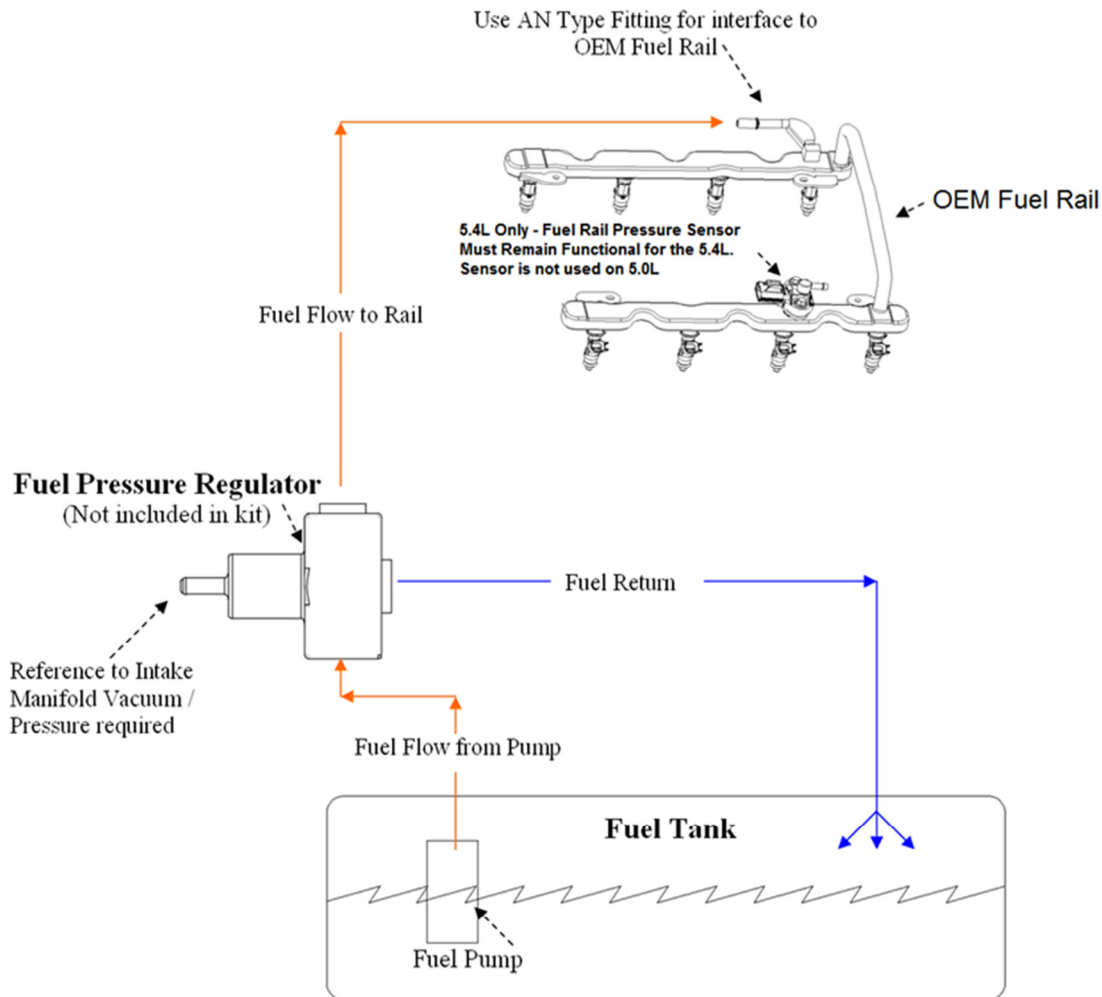

Fuel pump requirements: 155L/Hr minimum at 55psi

Fuel pump location

A common and often overlooked problem is the location of the fuel pump or pumps. Optimally, the fuel pump should be mounted IN THE TANK to reduce the possibility of pump cavitation. Cavitation is essentially localized boiling caused by a reduction in pressure, generally occurring on the inlet side of a pump. This localized boiling results in fuel vapor bubbles which will reduce the volume of fuel the pump is capable of delivering to the engine. Any reduction in pressure or increase in temperature at the inlet side of the pump increases the chances that cavitation will occur. For this reason, it is always best to either have the pump inside the tank immersed in fuel or (in the case of an external pump) gravity fed, which will increase the pressure on the inlet side of the pump. If the fuel pump has to "pull" the fuel, this will result in a reduction in pressure at the fuel pump inlet potentially allowing cavitation and, thus, vapor bubbles to develop. These vapor bubbles are then drawn into the fuel pump and exit the high-pressure side of the fuel pump as compressed vapor.

Factory Ford shop manuals are available from Helm Publications, 1-800-782-4356



FORD PERFORMANCE

Instruction Sheet

M-6017-M50A /504V 5.0L Controls Pack

NO PART OF THIS DOCUMENT MAY BE REPRODUCED WITHOUT PRIOR AGREEMENT AND WRITTEN PERMISSION OF FORD PERFORMANCE PARTS

They travel the entire length of the fuel system and are expelled through the fuel injector. This can cause issues ranging from stumbles and hesitations to engine damage due to insufficient fuel delivery and lean A/F ratios. Sometimes this problem can

characterize itself by only appearing when the weather gets warmer, which can confound the diagnosis of the issue. In certain cases, it may seem to only develop when driving on certain surfaces, because pavement reflects more heat than an off-road 4x4 trail. Remember, more heat and lower pressure on the inlet side of the pump means a greater chance of cavitation, which is to be avoided whenever possible.

If you are using an external mounted fuel pump, you should run a very coarse (typically around 100 micron) filter on the inlet side of the fuel pump, and a finer (typically around 10 micron) filter on the outlet side of the pump. A paper filter is NOT recommended on the inlet of the fuel pump because it can cause a restriction in fuel flow which, as mentioned previously, can lead to cavitation.

Warning: It is highly recommended that an inertia switch is incorporated into the fuel pump wiring to turn off the fuel pump in event of an accident.

9.0 Initial Start-Up

Note: The following information assumes completion of each of the previous steps of this installation manual.

- 9.1. Check all fluid levels, electrical and fluid connections.
- 9.2. Pressurize the fuel system by turning the key on. Inspect the entire fuel system (from tank to engine) for leaks.

!!! NOTE: If any leaks are found, do not proceed further until these have been corrected !!!

- 9.3. Start Engine.
- 9.4. Check for leaks and/or noises that may indicate a problem.

CAUTION: Be certain to run the vehicle in a well ventilated area.

10.0 Wire Usage Schematics

The following two pages detail the two most common wiring configurations—please choose one to complete installation of your controls pack kit.

Factory Ford shop manuals are available from Helm Publications, 1-800-782-4356



FORD PERFORMANCE

Instruction Sheet

M-6017-M50A /504V 5.0L Controls Pack

NO PART OF THIS DOCUMENT MAY BE REPRODUCED WITHOUT PRIOR AGREEMENT AND WRITTEN PERMISSION OF FORD PERFORMANCE PARTS

SETUP A

IGNITION

TOGGLE SWITCH*

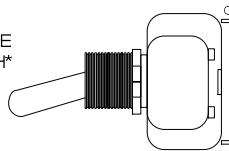

OUTPUT Ignition Relay Trigger (Light Green)

INPUT HAAT B (RD)

STARTER

MOMENTARY SWITCH*

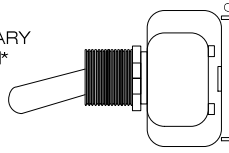

OUTPUT Starter Motor Request (SMR)(Light Blue)

INPUT HAAT B (RD)

C160B

FUEL PUMP*



Fuel Pump Relay Out (GN)

BATTERY*

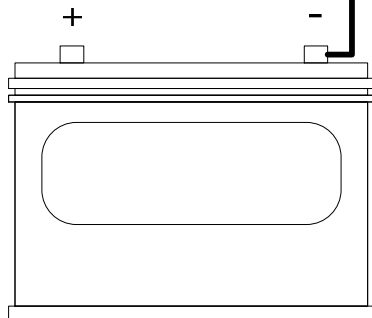

GROUND 14AWG*

* = NOT INCLUDED

Factory Ford shop manuals are available from Helm Publications, 1-800-782-4356



FORD PERFORMANCE

Instruction Sheet

M-6017-M50A /504V 5.0L Controls Pack

NO PART OF THIS DOCUMENT MAY BE REPRODUCED WITHOUT PRIOR AGREEMENT AND WRITTEN PERMISSION OF FORD PERFORMANCE PARTS

SETUP B

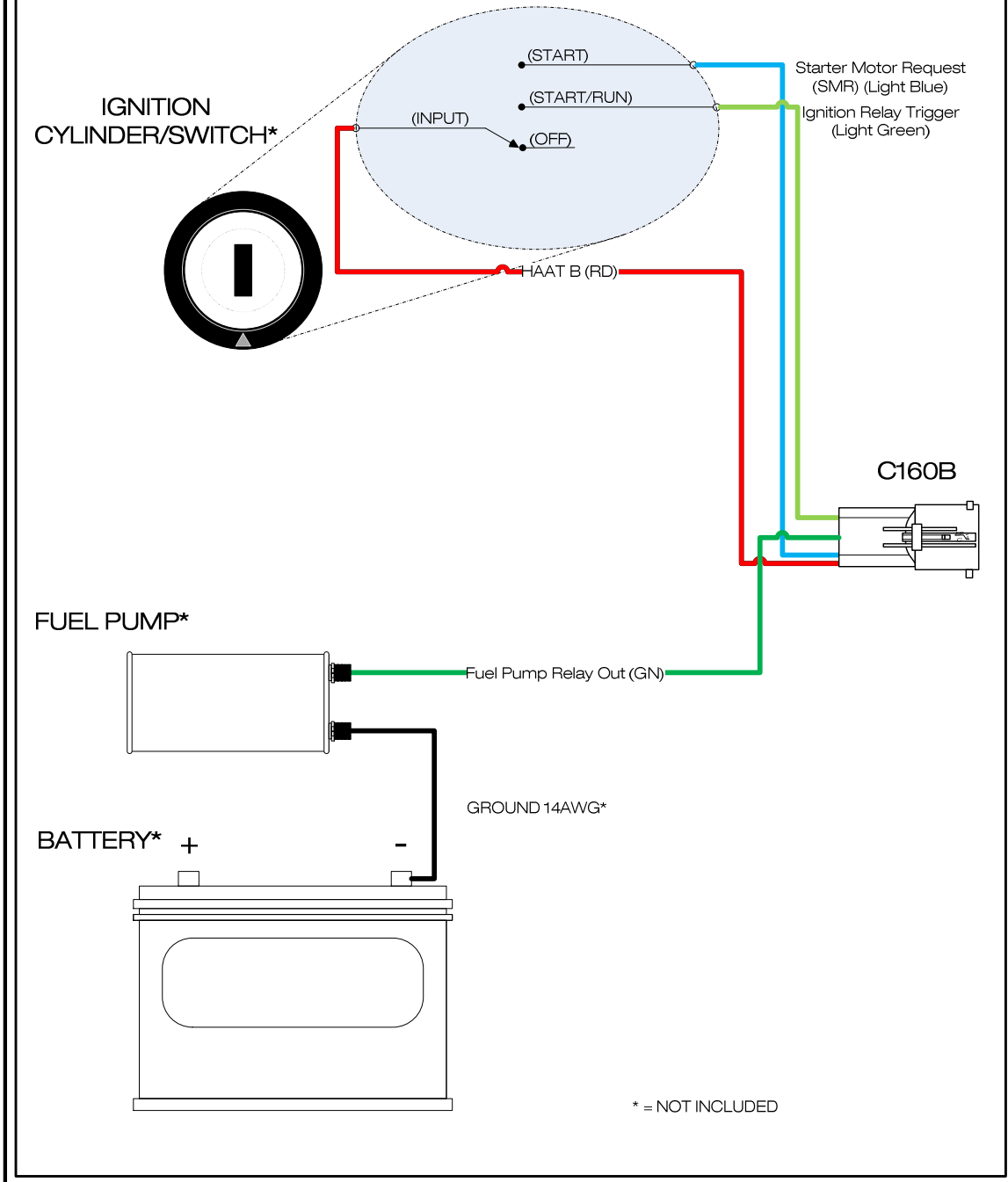

Factory Ford shop manuals are available from Helm Publications, 1-800-782-4356



NO PART OF THIS DOCUMENT MAY BE REPRODUCED WITHOUT PRIOR AGREEMENT AND WRITTEN PERMISSION OF FORD PERFORMANCE PARTS

11.0 Fuses & Relays

- The following diagram outlines the array of fuses and relays included in the controls pack wiring harness, and the function of each.
- NOTE: Do NOT replace any of the fuses with a higher value than those specified below.

Component ID	Type	Value	Name
JC1	J-Case Fuse	50A	PCM Relay Feed
JC2	J-Case Fuse	50A	Cooling Fan Relay Feed
JC3	J-Case Fuse	30A	Starter Relay Feed
JC4	J-Case Fuse	40A	Fuel Pump Relay Feed
JC5	J-Case Fuse	40A	Ignition Relay Feed
-	-	-	-
JC7	J-Case Fuse	NOT USED	NOT USED
JC8	J-Case Fuse	NOT USED	NOT USED
F1	Minifuse	20A	VPWR1
F2	Minifuse	20A	VPWR2
F3	Minifuse	15A	VPWR3
F4	Minifuse	15A	VPWR4
F5	Minifuse	10A	Ignition Switched A
F6	Minifuse	10A	Ignition Switched B
F7	Minifuse	15A	ICP
-	-	-	-
F9	Minifuse	15A	VPWR6
F10	Minifuse	10A	HAAT A
F11	Minifuse	10A	HAAT B
-	-	-	-
R1	Power Mini Relay	70A	PCM Relay
R2	Power Mini Relay	70A	Cooling Fan Relay
R3	High Current Micro Relay	40A	Starter Relay
R4	High Current Micro Relay	40A	Fuel Pump Relay
-	-	-	-
R6	High Current Micro Relay	40A	Ignition Relay

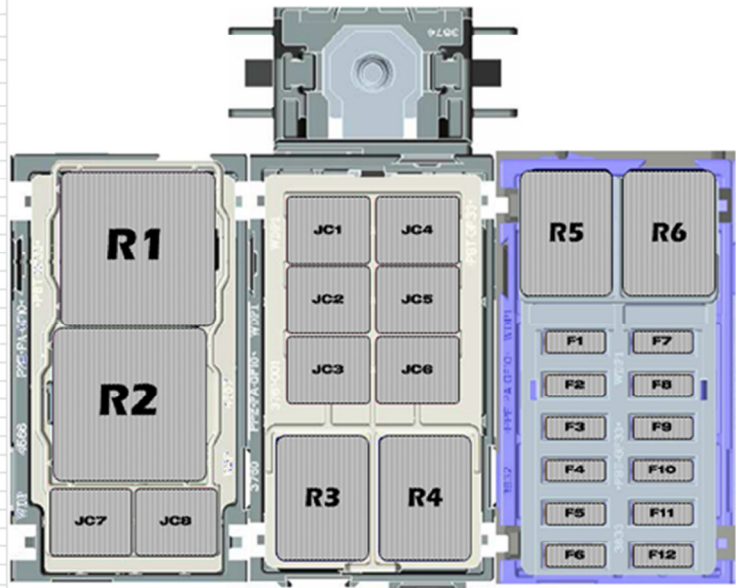

12.0 Troubleshooting tips:

The following troubleshooting tips are intended for you to run a few quick tests to roughly determine what the issues are before calling or find a solution yourself:

- Always double check all your grounds. The wirings included in this kit are extremely sensitive to ground issues. Secure all the connections from chassis grounds to battery negative. Do a continuity test with your multimeter between all your ground terminals and battery ground.
- Check for all you reference voltage 5V, make sure they are not short to elsewhere. Use a multimeter to measure the voltage. The reference voltage are sent out from PCM so if wirings are all good and still you have a different voltage level, PCM might not be properly calibrated.
- If you don't have any power at all, check for your ignition switch, ignition relay R6 and PCM relay R1 wirings. You should have 12V at both relay outputs once ignition on, which is fused via F5 and F1 separately. Again use a meter to measure the voltage at F5 and F1, 12V expected, there are tiny holes on all mini fuses for your probe to thrust in.
- If ignition circuitry works but no cranking, check for your starter switch and starter relay R3 wirings. You should have 12V at the relay output WHEN you push the start button. Use a meter to measure the voltage at the Starter solenoid leads from harness (disconnect from starter), 12V expected WHEN you push the start button.

Factory Ford shop manuals are available from Helm Publications, 1-800-782-4356



FORD PERFORMANCE

Instruction Sheet

M-6017-M50A /504V 5.0L Controls Pack

NO PART OF THIS DOCUMENT MAY BE REPRODUCED WITHOUT PRIOR AGREEMENT AND WRITTEN PERMISSION OF FORD PERFORMANCE PARTS

- If your engine will only crank but not fire up, fuel system malfunction can be the cause in most cases. First make sure that you have 12V at fuel pump + and all injectors when key on. Measure the pressure at your fuel rail it should start building up once you hit starter button.

13.0 Connector Faces

ALTERNATOR

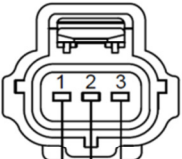

Battery Sense (B+) Always HOT! RD
 Regulator Control (ALTCOM) GENRC C-13 BU
 Load Indicator (ALTMON) GENLI C-26 VT

MAF/IAT Mass Air Flow Intake Air Temperature Sensor

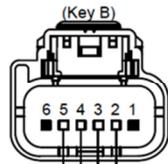

(Key B)
 IAT E-27 VT
 12V Key On GN
 MAFRTN C-54 BU
 MAF (Freq.) C-73 YE

APPS Accelerator Pedal Position Sensor

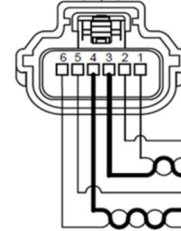

(Key A)
 * APP 1 C-61 YE
 * ETCREF (A) C-36 GN
 * ETCRTN (A) C-35 VT
 * APP 2 C-60 BU
 * ETCRTN (B) C-59 YE
 * ETCREF (B) C-40 BU

Clutch Pedal Bottom Travel Switch

(Normally Open)
(Key A)

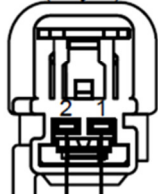

CPP-BT C-9 BU
 PWRGND BK

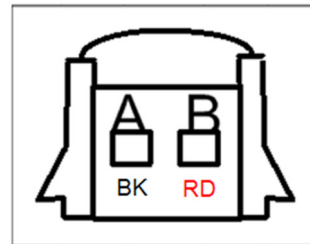

C400
 IC PUMP

Factory Ford shop manuals are available from Helm Publications, 1-800-782-4356



FORD PERFORMANCE

Instruction Sheet

M-6017-M50A /504V 5.0L Controls Pack

NO PART OF THIS DOCUMENT MAY BE REPRODUCED WITHOUT PRIOR AGREEMENT AND WRITTEN PERMISSION OF FORD PERFORMANCE PARTS

Diagnostic / Data Link Connector

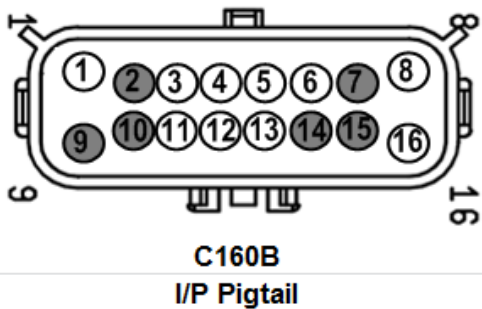
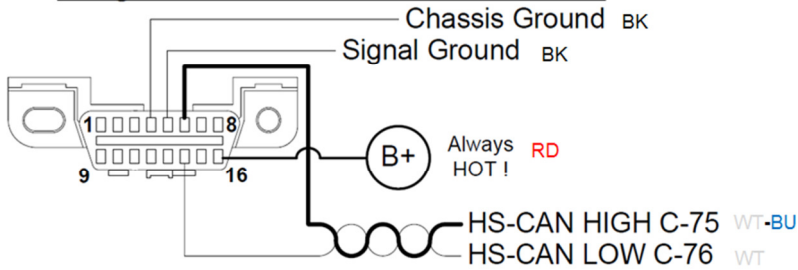

UEGO UPSTREAM

Universal Exhaust Gas Oxygen Sensor

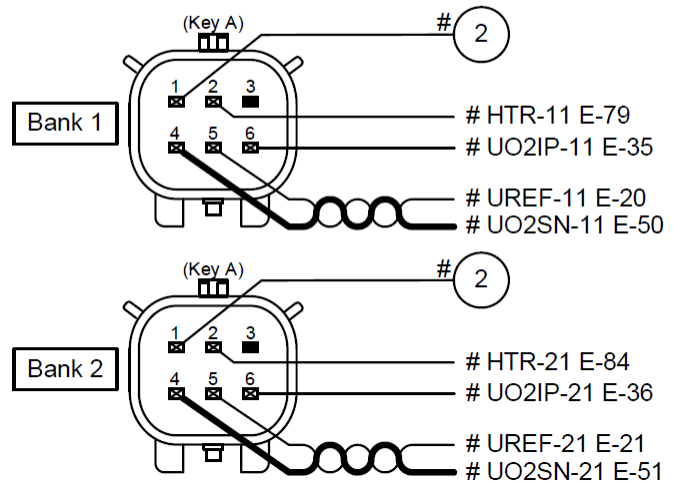

Factory Ford shop manuals are available from Helm Publications, 1-800-782-4356